

# Braillo Cut Operating Instructions

## Automatic Forms Cutter



Model 6609d-6612d  
Release: 12.12.2006



# List of Contents

<b>EC Declaration of Conformity</b> .....	4
<b>Safety Instructions</b> .....	5
<b>1. Setting up the machine</b> .....	5
<b>1.1 Selecting a location</b> .....	5
<b>1.2 Unpacking the machine and checking the parts</b> .....	5
<b>1.3 Parts list</b> .....	6
<b>1.4 Installing the stacker tray</b> .....	6
<b>1.5 Testing the forms cutter</b> .....	7
<b>1.6 Subassemblies</b> .....	8
<b>2. Starting up</b> .....	9
<b>2.1 Switching the machine on</b> .....	9
<b>2.2 Selecting the program</b> .....	9
<b>2.3 Loading paper</b> .....	9
2.3.1 Inserting the paper .....	9
2.3.2 Adjusting the edge blades .....	9
2.3.3 Automatic positioning of the forms .....	10
2.3.4 Paper adjustment with reader from above .....	11
2.3.5 Paper adjustment with reader from below .....	11
<b>2.4 Starting the forms cutter</b> .....	12
2.4.1 Display .....	12
2.4.2 Test cut .....	12
<b>3. Operating the machine</b> .....	13
<b>3.1 The operating terminal</b> .....	13
3.1.1 Introduction to the operation of the machine .....	13
3.1.2 Panel keys .....	14

3.1.3 Display messages .....	14
3.1.4 Further display functions .....	15
3.1.5 Information to the INFO-button .....	15
<b>3.2 The operator level (level 1) .....</b>	<b>16</b>
<b>3.2.1 Entering parameters .....</b>	<b>16</b>
3.2.1.1 Parameter b) <b>Length</b> .....	16
3.2.1.2 Parameter i) <b>Special Length</b> and j) <b>Program Sequence</b> .....	17
3.2.1.3 Parameter c) <b>Cut</b> .....	19
3.2.1.4 Parameter d) <b>Counter</b> .....	20
3.2.1.5 Parameter e) <b>Counter Function</b> .....	21
3.2.1.6 Parameter m) <b>Programming the fold length</b> .....	22
<b>3.3 The programming level (level 2) .....</b>	<b>23</b>
<b>3.3.1 Selecting and altering parameters .....</b>	<b>23</b>
3.3.1.1 Parameter a) <b>Label</b> .....	23
3.3.1.2 Parameter f) <b>Speed</b> .....	24
3.3.1.3 Parameter g) <b>Pause</b> .....	24
3.3.1.4 Parameter h) <b>Fine Position</b> .....	25
3.3.1.5 Parameter k) <b>Reader</b> .....	26
3.3.1.6 Parameter l) <b>Copy</b> .....	27
<b>3.3.2 Programming the OMR routines .....</b>	<b>29</b>
3.3.2.1 Explanation of terms relating to optical mark recognition (OMR) .....	29
3.3.2.2 Entering the 5-digit number for the pattern of marks (code) .....	32
3.3.2.3 Entering the 5-digit number for the functions .....	34
<b>3.3.3 Counter function ONLINE # 00 / # 01 .....</b>	<b>41</b>
<b>3.4 The technician level (level 3) .....</b>	<b>42</b>
<b>3.4.1 Service routines .....</b>	<b>43</b>
<b>3.4.2 Messages .....</b>	<b>48</b>
<b>4. Important notes and information .....</b>	<b>49</b>
<b>4.1 Cleaning and maintenance .....</b>	<b>49</b>
<b>4.2 Troubleshooting .....</b>	<b>50</b>
<b>4.3 Technical data .....</b>	<b>51</b>
<b>4.4 Technical change of the main PCB-s .....</b>	<b>52</b>
4.4.1 Connections and electrical settings.....	53
<b>Index .....</b>	<b>55</b>

# EC Declaration of Conformity with EC Directive on Machines (89/37/EG)

Müller Apparatebau GmbH

Industriepark  
85402 Kranzberg

hereby declares that the machines described below

6609-6614	Automatic Forms Cutter	6792	Check-terminal	6892	Compressor for Re/Unwinder 6801/6802
6615	Automatic Forms Cutter pinless/pinfeed	6795,6819	Slitter and Merger	6896	Transport Unit
6618,6619	Pinless-Automatic Forms Cutter	6797	Device for connection of a Hoover	6897	Slitcher (up to 20mm) right
6622	Transversal Accumulator		Unit Hose on the Cutter	6898	OCB" OMR Input from PC"
6624,6724	Conveyor Stacker	6798	Autoloader	6899	Rear Cover Tape Glue System
6625	Conveyor Stacker with 2 driving units	6799	Modification for Forms Cutter	6900	Insertor for C4 size
6626,6628	Multichannel System	6801	Rewinder	6901	OCB" Remonte control PC"
6627,6727	Drop Stacker-Conveyor Belt	6802	Unwinder	6902	Enclosure Feeder
6630	Outsorter/Deflector	6809	Autoloader- Standalone	6903	"HIGH SPEED" Accumulator
6650-6653	Drop Stacker	6815	STOP-Function	6904	OMR .....
6654	Receiving Tray - Online	6816	Slitcher (stitch bottom right)	6905,6908,6918	Colour Reading Head
6655	Receiving Tray - Standard	6817	Active drive	6907	Bypass Module
6656	Drop Stacker for online applications	6819	Slit & Merger	6910	OMR Scanner
6680/6681	Catalog-Dispencer	6820-6825	Folder	6912	Sheet rotator 90°
6683/84/86	Cut-Sheet-Feeder	6826	STOP-Function	6916,6917	OMR top and bottom for 6618
6685	Post Accelerator	6827	Slitcher (stitch top left)	6920	External OMR input, online
6687	Cut Sheet Feeder - HIGH SPEED	6828	Slitcher (stitch bottom left)	6922	Automatic Drop Stacker 26"
6688	Enclosure Feeder	6829	Throughput Station Standalone	6924	Sheet Rotator 90° for 4"
6692/93/99	Sequencer	6833	Glueing Modul	6926	Accumulator Conveyor for 16"
6700	Optical Mark Recognition	6836	Grooving Unit	6927	2D-Code Reading
6703-6705	Optical Mark Recognition	6837	Turnover Unit	6928	Compressor for Rear Cover Tape Glue system
6701,6719	Loop Control Unit	6842	Sheet Rotator	6932	Drop Stacker 26"
6706,6731	Additional Power Supply	6843	Suction Opener	6936	Adapter for Core D=200mm
6707	Single Cycle Synchronisation	6845,6861	Transport Unit	6937	Adapter for Core D=150mm
6708	Job Separator	6847	Programming Terminal for Folder	6939	Drive unit for Printer Station
6711	Vertical Slitters Left and Right	6848	Conveyor-Belt	6940	Envelope Turn Over Unit for Insertor
6712	Remote Control for Forms Cutter	6849	Anti Static Device	6941	Enclosure Feeder DL-Size
6717	Masterterminal	6850	Center Slitter for Cut Sheet	6942	Deflector Unit (special) downwards
67..	Black-Box	6852	Waste Extraction Unit	6943	Stack Tower
6730	Transport Unit	6862	Waste Evacuation f. Slitter and Merger 6795	6944/6958	Alignment Unit
6731	Power Supply	6866	Bypass Module	6945	Alignment Device with job separation
6737	Barcode-Scanner CLV 210 (BCR)	6867	Center slitter (4-10mm)	6946	Bypassmodule with Input plate
6750	Optical Character Reading (OCR)	6869	Pressure Heat-sealing System	6947	Conveyor Stacker for envelopes
6762	Digi-Switch for counter function	6870	Alignment Device	6949	Envelope turn over unit for Franking Machine
6765,6813,6818,6830,6896	Transport Unit	6871	Single sheet takeover unit	6950	Merger
6766	Slitcher (stitch top right)	6875	Center Slitter	6954	Alignment Device with job separation
6772-6776	Optical Mark Recognition (OMR)	6876	Driving Entry Unit	6960	Deflector Unit for DL, C5 and C4 size
6779	Shingling Accumulator	6878	Facsimile Signatures	6961	Accumulator HIGH SPEED for A4 portrait
6780	Center Slitter	6883,6893,6894,6895,6945	"HIGH SPEED" Accumulator	6970/6980	Vacuum Feeder
6781,6785	Optical Mark Recognition (OMR)	6885	Device for connection of a Hoover Unit Hose	7006/7010/7015	Insertor for DL size
6783,6829	Throughput-Station	6887	Single sheet takeover unit	8006/8012	Insertor for DL size + C5
6784,6814,6856	Transport Unit	6888	Rear Cover Tape Glue System	9820-9825	Sword Folding Machine
6786	Accumulator	6890	Transport Unit to laser printer	9826	Stop-Function
6787	Continuous web 90° Turnover Unit	6891,6911	Bypass Module		
6790	Cutsheet Guillotine				

conforms with the following EC directives:

Machine directive "98/37/EG"  
Low voltage directive 73/23  
EMV directive 89/336

Standards and technical specifications:

- EN 292-1, EN 292-2 "Safety of machines"
- EN 294 "Safe distances to prevent upper limbs from touching danger points"
- EN 349 "Minimum distances to prevent crushing of body parts"
- EN 60073 "Coding of display devices and control elements using colours and other means"
- EN 60950 "Safety of information technology equipment including electric office machines"

Kranzberg, den 28.06.2006



Manfred Müller  
General Manager

## Safety Instructions

Before operating this machine please read carefully the following instructions for your own safety and for safe operation of the machine.

This machine may only be operated by trained staff. The manufacturer disclaims liability for injuries occurring during unauthorized operation.

This equipment must not be installed or altered, and the housing must not be opened, by anyone other than a trained service technician.

Make sure that the electricity supply conforms with the voltages given on the machine.

This machine may only be operated using the cable supplied.

Do not connect and disconnect the interface connector while the power is switched on. Wait at least 10 seconds after switching the machine off and on.

Except for the service routines given in the operating instructions you should never attempt to repair the machine yourself. If problems arise call the service technician at your customer service centre.

Keep long hair, fingers and jewellery well away from rotating machine parts.

## 1. Setting up the machine

### 1.1 Selecting a location

The following factors are important in selecting a location for the machine:

- Avoid direct sunlight, heat and damp.
- Always use an earthed socket with no adapter plug.

### 1.2 Unpacking the machine and checking the parts

Unpack the machine and check that no damage has occurred during transport.



Two persons are required to **set up** the machine. Hold the automatic forms cutter on the bars of the base rack and stand it on its feet. Never hold the machine e.g. at the display or the cover.

**Risk of breakage!** Remove all PU parts (transport protection).

For your information: You will find the stacker plate (optional) in the waste container.

**Fix the machine in position by unscrewing the adjustable feet!**



### 1.3 Parts list

1	<b>Automatic Forms Cutter</b>
1	<b>Abfallbehälter</b>
1	<b>Stacker tray (optional):</b>
1	Tray
1	Left side piece
1	Right side piece
2	Knurled screw
2	Washer
2	Screw
8	Disc spring
2	Washer
4	Paper stop
2	Paper holder

Items , , are fixed to the side pieces , with a nut. The nut is for transport protection only and is not required for installation.

### 1.4. Installing the stacker tray

1. Unpack all parts. Unscrew the fasteners , , on the side pieces , . These parts are fixed to the side pieces with a nut. The nut is only for protection during transport. Make sure that the disc springs are fitted in the correct position.
2. Screw the side pieces to the stacker tray and hang in position on the back of the machine.
3. Fit the paper holder . To do this, unscrew the clamps ● on the rod ● at the back of the machine and fasten the paper holder with the screws ●.
4. Position the 4 paper stops .

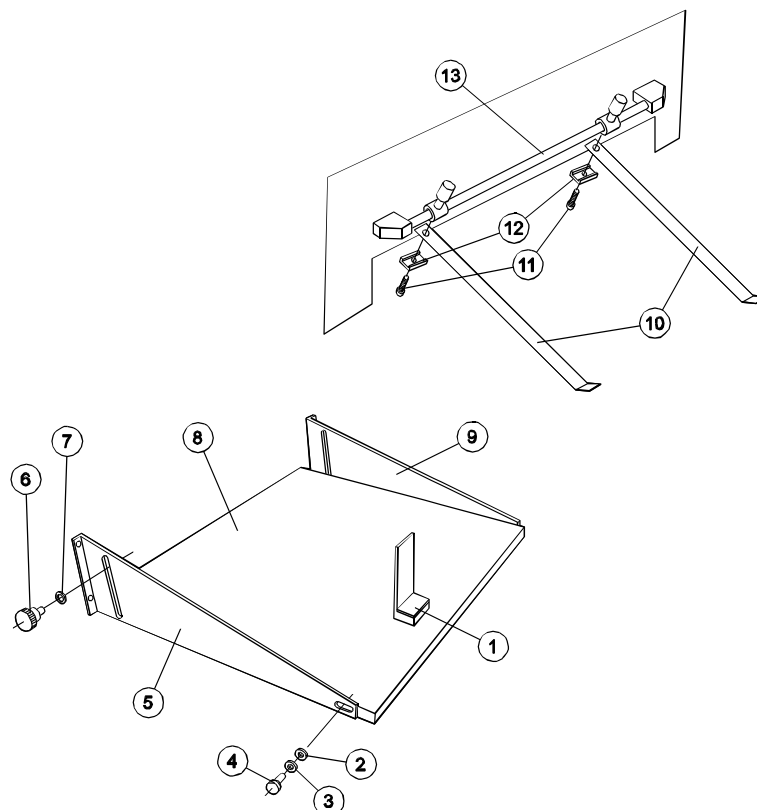

## 1.5 Testing the forms cutter

Before beginning to operate the forms cutter remove the protective covering from the feed plate. If it is not removed, the paper will become statically charged and will affect the cutting process.

Before switching the machine on, test the action of the upper blade as it moves to meet the lower blade. This is vitally important, as otherwise the cross cutter may be damaged.

This check is absolutely essential as the machine may have become maladjusted during transport.

Proceed as follows:

1. Unscrew the housing from the right side wall of the forms cutter.
2. Slowly turn by hand the large belt pulley to which the connecting rod is fastened. No strong resistance should be felt.
3. Raise the upper blade to its maximum position by turning the pulley. From the back of the forms cutter insert a sheet of paper on the far left between the upper and lower blades and perform a cross cut by turning the pulley slowly. The cross cutter should begin cutting approx. 10 mm from the left edge.
4. If necessary adjust the engagement of the blades by turning the adjusting screw.
5. Screw the housing in position.
6. Before connecting the power supply check the voltage again.
7. Connect the power supply. The forms cutter is now ready for operation.

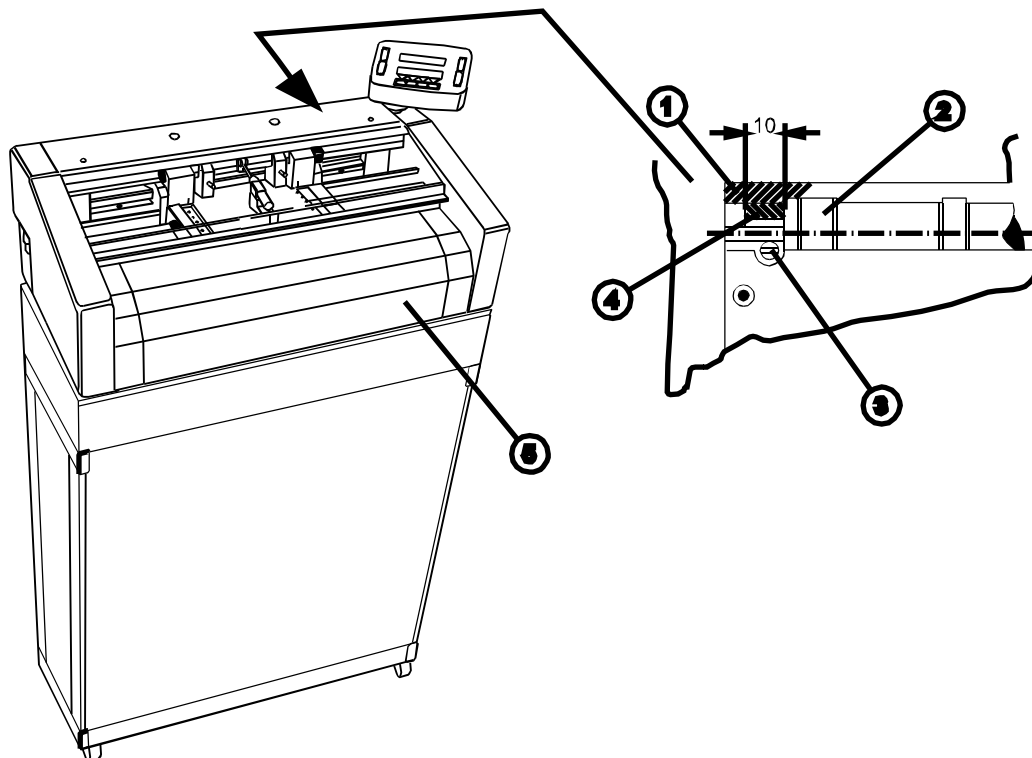

### 1.6 Subassemblies

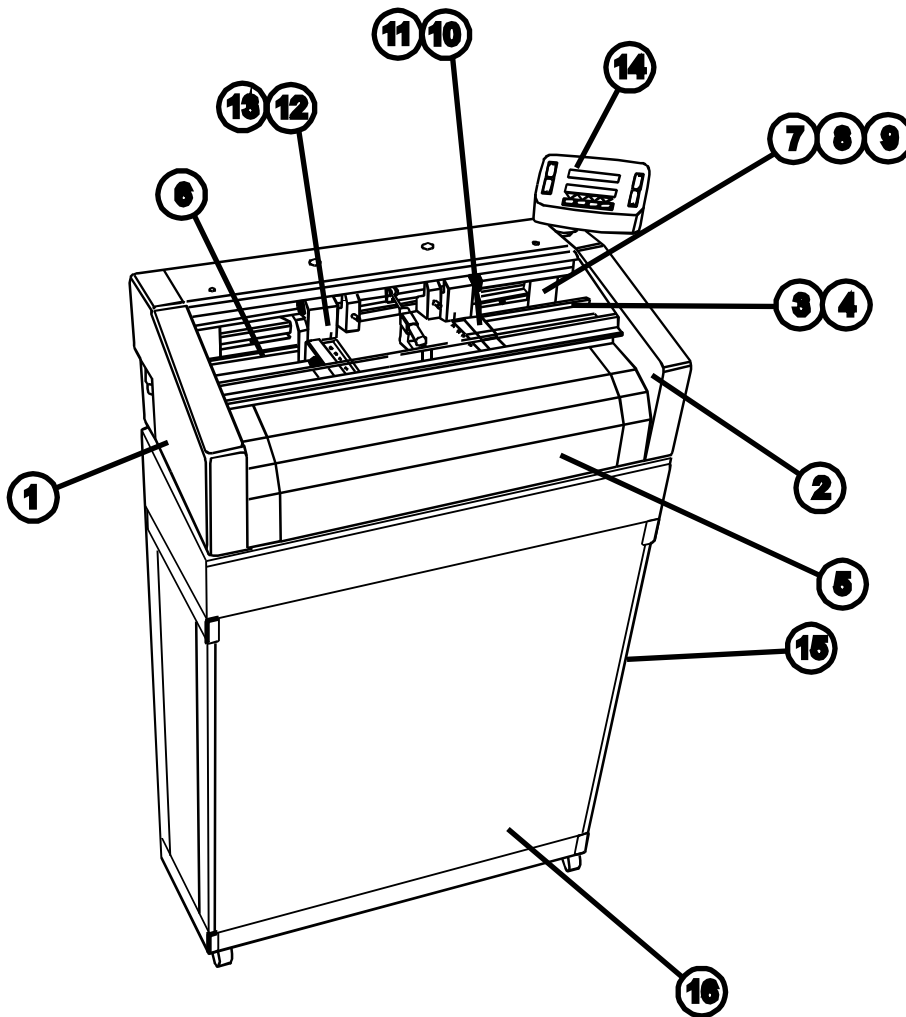

Subassemblies	Illustration (=Pos.)
Housing and cover sheets	1
Chassis	2
Driving shafts for Randschneider	3
Driving shafts for Tractor	4
Chassis and Platine	5
Safety cover	6
Cross cutter - blade bar	7
Cross cutter - ejector	8
Cross cutter - driving unit	9
Tractor unit	10
Tractor left and right	11
Edge cutter unit	12
Edge cutter left and right	13
Terminal	14
Electronic	15
Stand	16
Fan	17



## 2. Starting up

### 2.1 Switching the machine on

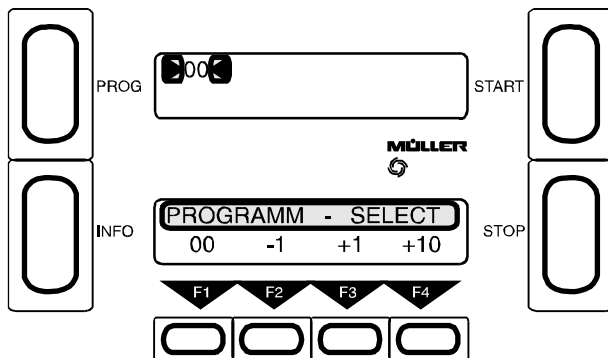

The machine is switched on by the power switch. The display then shows a message for about 3 seconds (display version, serial no., model no.), which can be held in the display by pressing the stop button.

When the button is pressed again the current counter position appears. When the button is released, the program last used is shown. If any other equipment is connected, it will return to its starting position (e.g. lowering stacker).

### 2.2 Selecting the program

The display shows the program last used. If you want to use a different program, you can select it with buttons **F1-F4**. New programs can be entered in program slot 00 **only**, and stored in slots 01-83 (see also Section 3.3 "The programming level"). Every time the machine is switched on, fixed programs from the EPROM memory overwrite program slots 84-99.

### 2.3 Loading paper

#### 2.3.1 Inserting the paper

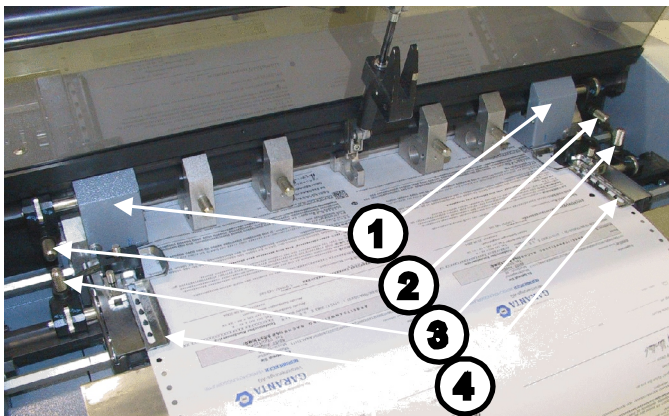

Open both tractor covers and release the tractor screws. Set the tractors at approximately the width of the paper but do not lock them. Insert the paper. Make sure that the leading edge is **cleanly torn off**, as otherwise the paper will not be cut on the cross-perforation. Now close the tractor covers and position the paper in the centre of the machine. Use the centre paper guide as an aid. Fix the screws on one of the tractors and adjust the tension of the paper by moving the second tractor. The paper should be neither very tight nor very loose. Then fix the screws on the second tractor.

**Fine adjustment:** This device can be used to fine adjust the tractor to a certain position using the adjusting wheel (position the tractor first).

#### 2.3.2 Adjusting the edge blades

Release the screws of the edge blades and fix them after setting to the desired width. The maximum width is 28 mm (option available: extra wide edge cutter max. 60 mm). The red arrow indicates the cutting position of the edge blade. After setting the required width, lock both edge blade blocks again.

**Fine adjustment:** This device can be used to fine adjust the edge cutter to a certain cutting position using the adjusting wheel (position the edge cutter first).

### 2.3.3 Automatic positioning of the forms

After the paper has been inserted, series 6600 formscutters position the forms automatically at the blade edge on starting or on changing programs. The central paper guide contains a light-guide fibre optics system, which has two functions:

1. Recognising end-of-paper
2. Automatic positioning of paper on the cutting edge

If the paper is inserted in the tractors in such a way that it does not reach the optical scanner, the tractors will transport the paper automatically forwards to the scanner after the **Start** button has been pressed, and then under the cross blade for the first cut.

If the paper is inserted in such a way that it already covers the optical scanner, the tractors will move in reverse direction to the scanner after the **Start** button has been pressed and then forwards under the cross blade.

Due to this automatic positioning the paper can be inserted without any need to position it accurately. Before paper is inserted in the machine, it is important to check that the leading edge of the paper has been cleanly torn off at the cross-perforation. This is necessary because, due to the automatic positioning of the paper on the cutting edge, the forms will otherwise not be cut exactly on the cross-perforation.

The machine automatically recognizes the leading edge of the paper and transports it immediately to the cutting edge. If the leading edge is damaged or if a piece has already been cut off, the machine will not position the paper correctly with the cross-perforation on the blade edge. Any correction made using the fine adjustment control will be automatically applied each time paper is inserted.

We recommend that you tear off one sheet of paper before every new start. This also helps to prevent jamming due to the cuts made by the edge blades.

#### Caution!



The end-of-paper light barrier must not be covered by the paper-holder as this means the paper cannot be detected.

On starting, the machine would run in reverse direction and would eject the paper in reverse direction into the tractor.

If the paper-holder becomes twisted during continuous operation so that it covers the light barrier, the forms cutter will not stop at the end of the paper.

**2.3.4 Paper adjustment with reader from above**

(See also 3.3.1.5, parameter k)

If the operator starts an **OMR program**, the paper will not be aligned on the cutting edge. The optical mark reader evaluates the OMR marks printed on the paper. When the **Start** button is pressed the first mark is positioned at a reading head.

Please note: There are two different positions of the reading head!

**1/6" processing:**

The adjustment line (AL) must be visible in the groove of the reading head (see scetch).

**1/8" processing:**

The adjustment line (AL) must have 0,6 mm distance to the reading head. Measure the distance always from the middle of the reading mark.

Adjusting the reading head: The reading head can be moved in the feeding direction and sideways by loosen the set screws

If the adjustment at the reading head is not sufficient to bring the reading mark in the position as described above, the reading area of the adjustment line must be entered one line before or below under parameter k), .

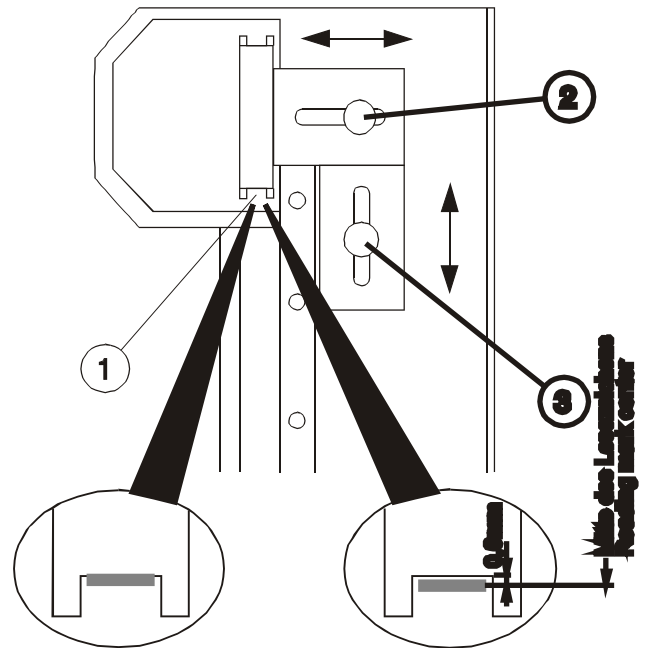

**2.3.5 Paper adjustment with reader from below**

(See also 3.3.1.5, parameter k)

With reading from below the OMR mark cannot be detected when positioning the paper. So you have to make a punch in the paper as below.

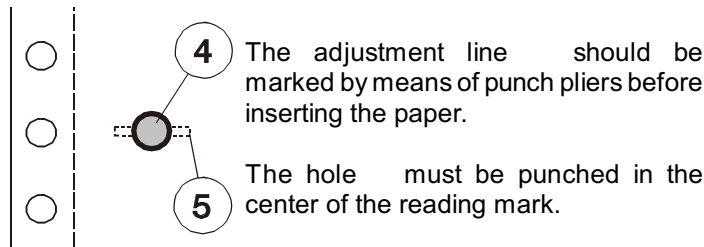

Please note: There are two different positions of the reading head!

**1/6" processing:**

The adjustment line (AL) must be visible in the groove of the reading head (see scetch).

**1/8" processing:**

The adjustment line (AL) must have 0,6 mm distance to the reading head. Measure the distance always from the middle of the reading mark or from the middle of the hole.

After pressing the **Start** - button the first reading mark is positioned at the reading head.

Adjusting the reading head: The reading head can be moved sideways by the set screw and in the direction of feed by moving the plate. If the adjustment at the reading head is not sufficient to bring the reading mark in the position as described above, the reading area of the adjustment line must be entered one line before or below under parameter k), .

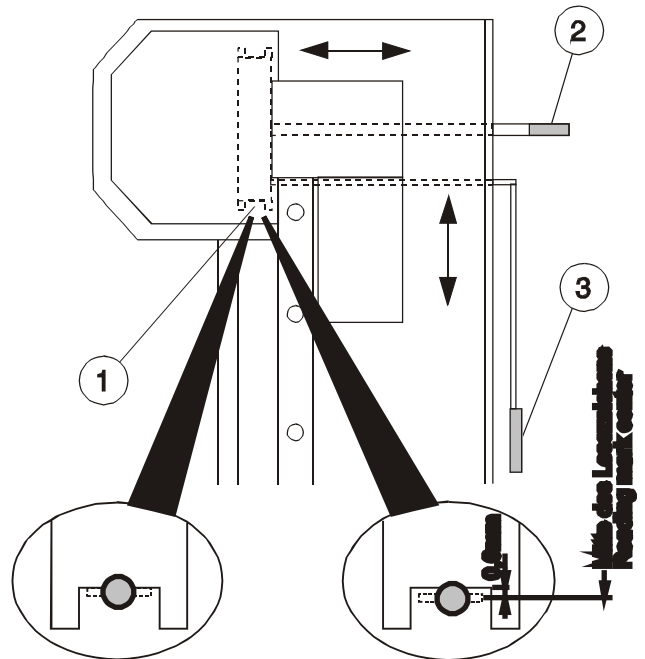

## 2.4 Starting the forms cutter

When the paper has been positioned by pressing the **Start** button (Section 2.3.3), the word **READY !!!** appears in the display, or if an OMR program is being used the word **ADJUST**. To start the machine, press the **Start** button again to begin continuous operation.

### 2.4.1 Display

The starting speed increases continuously during cutting of the first sheets, until the set maximum speed is reached. During continuous operation the fine position (cutting edge), the feed rate and the pause between two forms can be altered. The preset counter, the actual counter and the group counter are also shown.

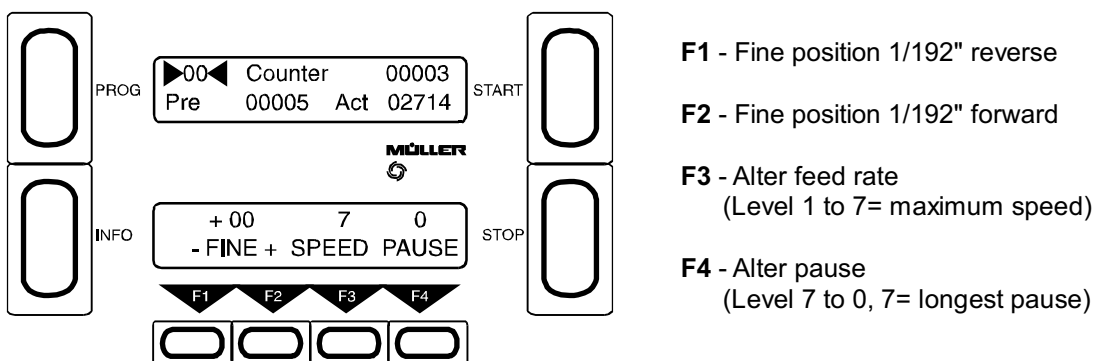

All these changes will be automatically saved in the current program.

### 2.4.2 Test cut

By pressing the **Start** and **Stop** buttons simultaneously it is possible to cut single sheets as a test. When the Stop button is pressed, the forms cutter always stops at the end of the current cycle. The paper is positioned with the perforation at the blade edge.

### 3. Operating the machine

The operation of the machine is divided into three levels:

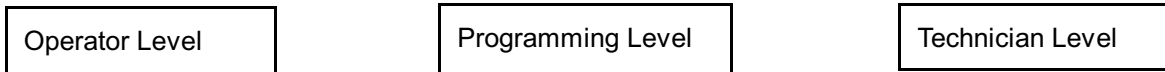

Areas which are not intended for the operator are protected by special **access options**.

On the programming level **all** function parameters of the paper cutting machine can be accessed and programs can be set up and saved.

The technician level operates in an additionally protected area. Service routines can be started. Information about the condition of the machine can be read.

#### 3.1 The operating terminal

The operating terminal is on the right-hand side of the machine.

On this terminal are:

4 large buttons **PROG, INFO, START and STOP**, two LEDs each containing 2 lines for 20 characters, and 4 small multifunction buttons **F1-F4**. The functions of these buttons are always shown in the lower display.

##### 3.1.1 Introduction to the operation of the machine

Explanation of terms

<b>Parameter</b>	Before forms can be cut, a number of different values have to be set, such as sheet length, type of cut or speed. These values are called <b>parameters</b> . The parameters are entered via the terminal.
<b>program</b>	A program consists of several parameters. The programs are saved in the terminal. Up to 100 programs can be saved. The programs saved are numbered continuously from 00 - 99.
<b>Program structure</b>	Imagine the arrangement of the programs, each with its individual parameters, like a card file. Each program represents one index card. The individual parameters are recorded on the index card.
<b>Program selection mode</b>	In program selection mode, any program that has been saved can be selected. To do this the "function buttons" F1, F2, F3, and F4 are used. When the desired program appears on the upper left display, the machine can be started by pressing the <b>Start</b> button. The slots for working programs are numbered from >01< to >99<.
<b>Parameter mode</b>	Parameter mode can be called from program selection mode by pressing the <b>Prog</b> button. In parameter mode two basic functions can be selected: <ol style="list-style-type: none"> <li>1. Parameter <b>selection</b> mode</li> <li>2. Parameter <b>input</b> mode</li> </ol>

New programs are always entered in PROG 00

### 3.1.2 Panel keys

The 4 panel keys have the following functions:

<b>PROG</b>	The PROG button switches between the functions <b>program</b> selection and <b>parameter</b> selection.
<b>INFO</b>	The INFO button gives information referring to this instruction manual. If the OMR system is used during STOP the code is displayed. (For service functions see Section 3.1.5).
<b>START</b>	This button starts the machine.
<b>STOP</b>	When the STOP button is pressed, the machine will stop at the end of the current cycle.

The PROG and INFO buttons have no function during continuous operation.

### 3.1.3 Display messages

The following messages can appear on the display:

<b>PAPER ???</b>	If there is no paper in the forms cutter the word PAPER ??? will appear in the lower display and the machine will stop. The forms cutter also stops at the end of the paper.
<b>COVER ???</b>	If the transparent cover is opened or even just slightly lifted during operation, the lower display will show COVER ??? and the machine will stop at the end of the current cycle.
<b>READY !!!</b>	This message appears after the paper has been positioned at the blade edge before starting the machine. When the <b>Start</b> button is then pressed, continuous operation begins.
<b>CALL SERVICE</b>	If a 3-digit number (e.g. 031) is shown, this is a sign of malfunction. Make a note of the 3-digit number and inform the service technician. (For service messages see Section 3.4.2),
<b>INTERFACE</b>	The interface connection on the machine or on an additional machine is defective. The service technician should be informed.
<b>ID-CHIP</b>	The ID-chip on the main board is missing or is defective - inform service technician.
<b>COOLING FAN</b>	The filter needs cleaning. Additional fan defective (applies to model 6611/6612 only) - inform service technician.
<b>ADJUST</b>	When using the OMR system (the adjustment line is within the groove of the reading head) the reading head can now be adjusted. For further information see Section <b>Reader</b> .
<b>READ ERROR</b>	The code that has been detected is shown in the lower window on the display (e.g. 0000000001001001). For further information see Section <b>Reader/Read errors</b> .
<b>STOP</b>	Appears when the <b>Stop</b> button is pressed.

### 3.1.4 Further display functions

**SLOW FLASHING** of numbers indicates that input is possible. The set values can be altered or new values can be entered or selected.

**FAST FLASHING** of numbers indicates that the next working step must now be carried out, e.g. pressing a function key to carry out or end an operation.

**DISPLAY TEXTS** All texts in the display are available in various languages which can be obtained by starting the appropriate service number (see Section 3.4.1 SERVICE ROUTINES).

**(R)** The sign (R) in the operating instructions stands for "rotating function", i. e. after the last value or position has been reached, the first value or position will reappear.

In addition all keys which display several responsive values have a repeat function, i.e. by holding the button down it repeats its function.



..... Panels with a grey background in the operating instructions indicate a flashing display. See above for notes on the flashing speed.

### 3.1.5 Information to the INFO-button

After pressing the **INFO-button** a number appears on the display. This number represents sections - as the table shows - in the operating manual.

INFO-Nr.	section	contents
1	2.2	Selecting the program
2	3.3.1.1	Parameter a) <b>Label</b>
3	3.2.1.1	Parameter b) <b>Length</b>
4	3.2.1.3	Parameter c) <b>Cut</b>
5	3.2.1.4	Parameter d) <b>Counter</b>
6	3.2.1.5	Parameter e) <b>Counter Function</b>
7	3.3.1.2	Parameter f) <b>Speed</b>
8	3.3.1.3	Parameter g) <b>Pause</b>
9	3.3.1.4	Parameter h) <b>Fine Position</b>
10	3.2.1.2	Parameter i) <b>Special Length</b>
11	3.2.1.2	Parameter j) <b>Program Sequence</b>
12	3.3.1.5	Parameter k) <b>Reader</b>
13	3.3.1.6	Parameter l) <b>Copy</b>
14	3.3.1.7	Parameter m) <b>Programming the fold length</b>

### 3.2 The operator level (level 1)

After switching the machine on the operator can carry out various functions. He can:

- select and start programs (00 - 99).
- browse through parameters b) - e) and possibly also i) and j), if parameter b) = 000, in all programs.
- alter parameter d) COUNTER in all programs.
- Change parameter m) fold length in all programs.
- alter parameters b) - e) (possibly also i) and j))in program slot 00.

#### 3.2.1 Entering parameters

After the machine is switched on, the message PROGRAM - SELECT appears on the display. The desired program can be selected by pressing buttons F1-F4. The program selected then appears in the left upper display. Press the **Prog** button to obtain PARAMETER - SELECT. Use buttons **F1** and **F2** to browse through the parameters.

##### 3.2.1.1 Parameter b) Length

In the Length parameter you can set the FORM LENGTH . The form length is measured in 1/6" (1 inch = 25.4mm) or 1/8" line space. Measure the form first on the plexiglass cover. Give the full length from perforat ion to perforation (including double cuts where necessary). The 1/6" or 1/8" step also applies when using the OMR system. If a form is to be cut into several pieces, this can be enter ed with the Special Length program i), j).

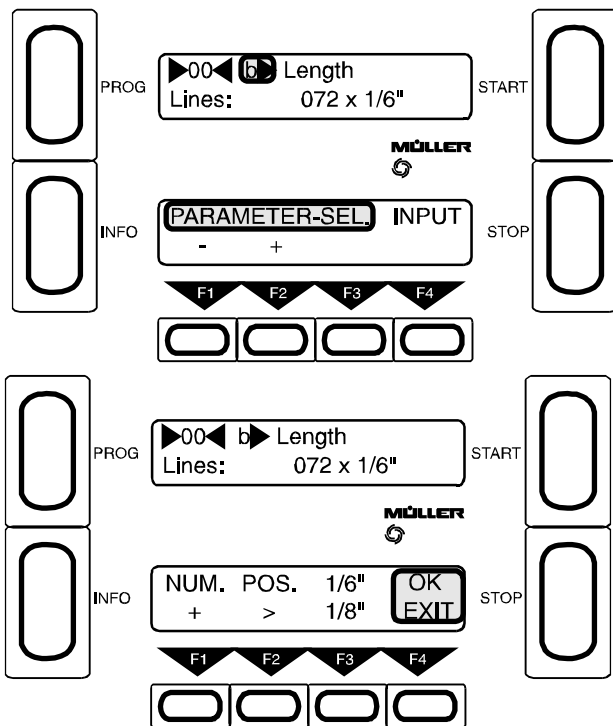

F4 - Press Input

- Select length:
- F1 - Select number (0-9) (R)
  - F2 - Current write position =\_ (R)
  - F3 - 1/6" or 1/8" length step
  - F4 - Exit



3.2.1.2 Parameters i) **Special Length** and j) **Program Sequence**

Before parameters i) and j) can be shown at the operator level, you must input the following information.

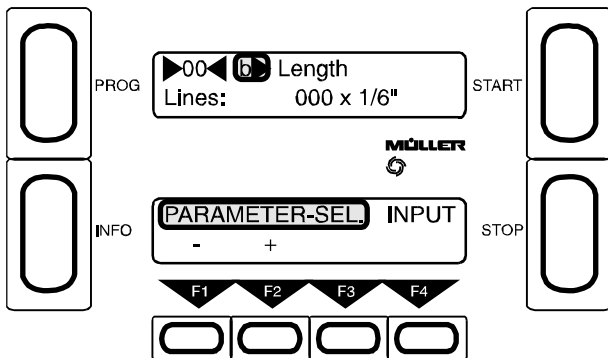

Select parameter **b)** and set Length to 000.  
Special Length is only possible with Length 000. Special Length can **not** be used together with the OMR system.

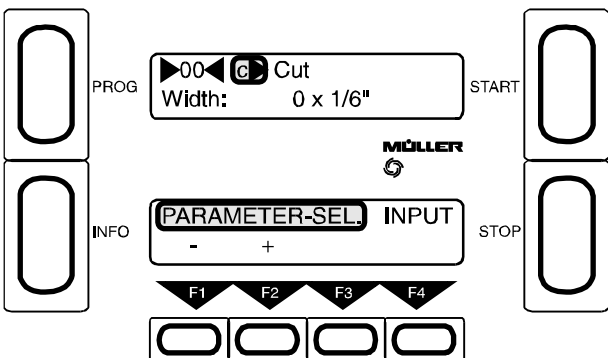

Select parameter **c)** and enter the length step for Special Length (**1/6", 1/8" or 1/24"**).  
The length step in parameter b) is not applicable!

Parameter i) **Special Length**

Here you can enter up to 4 different lengths. The order is not important at this point. The sequence of lengths is set in parameter j).

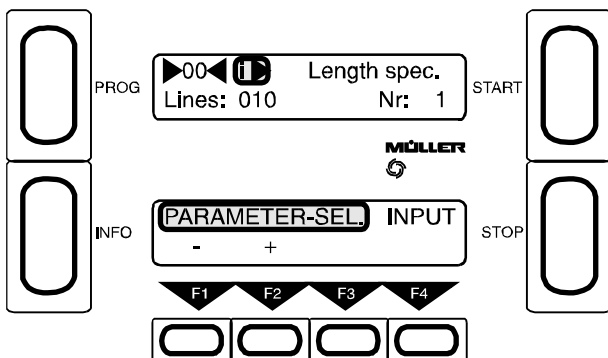

**F4** - Press Input

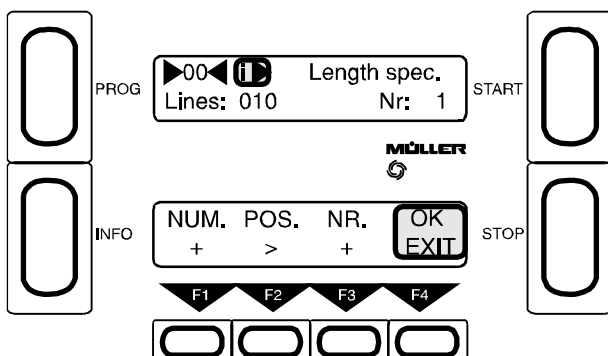

Enter length:

**F1** - Select number (0-9) e.g. 10x1/6" (R)  
(1/6" is set in parameter c)

**F2** - Current write position =\_ (R)

**F3** - Length no. 1-4 (i.e. up to 4 different lengths can be entered) (R)

**F4** - Exit

Parameter j) **Program Sequence**

The lengths in parameter i) can now be entered in the desired sequence under the numbers 1-9. The machine passes through all positions from 1-9 in every cycle. When length 0 is entered, this position is passed over without action in the program sequence.

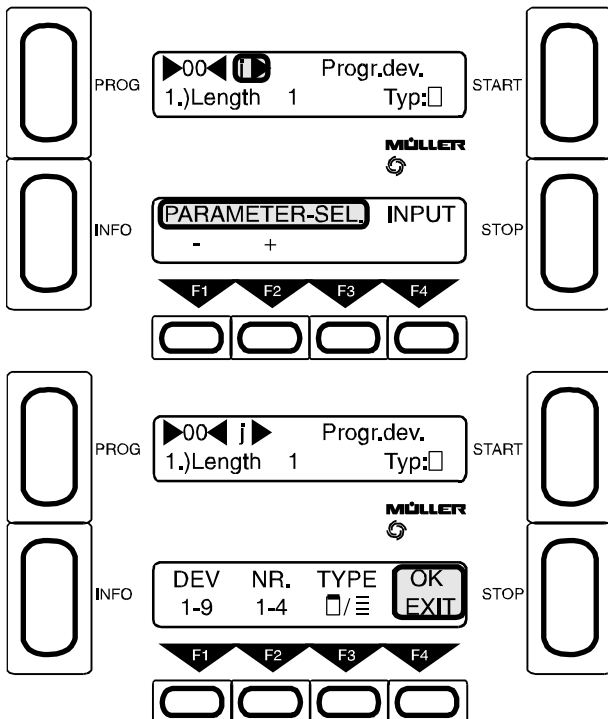

F4 - Press Input

F1 - Sequence (1-9) (R)  
 F2 - Length 1-4 or 0 from parameter i) (R)  
 F3 - Form will be chopped   
 Form will not **not** be chopped

F4 - Exit

Multiple distribution of lengths 1-4 from parameter i) among positions 1-9 is also possible. In addition, it is possible to decide at each position (1-9) whether the length 1-4 displayed here is to be performed completely or whether the form is to be chopped.

Chopping width: 3/6" means that a feed length of 2" will be cut with 4 cycles (1 cycle = 3/6").

When using **counter function ONLINE #00/#01** (see section 3.3.3) note the following:  
 The function entered under line #01 is carried out until the section before the last section is reached.  
 The function entered under line #00 is carried out when the last section is reached.

**Possible cuts with Special Length:**

The following example is stored in the machine under program slot 99 (fixed program):

Parameter i) Special Length (1/6" is set in Length c)):

- No. 1 - 002 x 1/6"
- No. 2 - 004 x 1/6"
- No. 3 - 020 x 1/6"

Parameter j)  
 Program sequence:

- 1.) Length 2
- 2.) Length 3
- 3.) Length 1
- 4.) Length 3
- 5.) Length 1
- 6.) Length 3
- 7.) Length 2
- 8.) Length 0
- 9.) Length 0

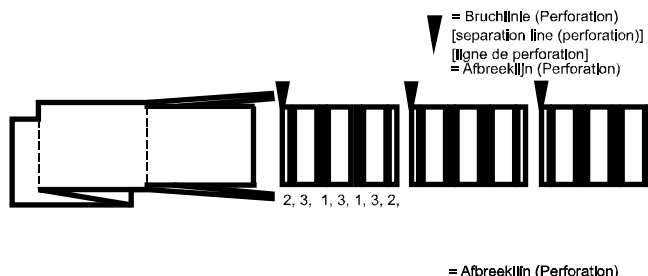

The type of cut in our example is 'do not chop'.  
 But it could also be 'chop', e.g. in program sequence i), point 6.), length 3.

3.2.1.3 Parameter c) Cut

Here you can set the type of cut (single cut, double cut or only edge cut without cross cut), the width of cut and the cut width step (1/6", 1/8" or 1/24") for double cuts.

**Single cut** is obtained by entering e.g. 0 \* 1/6" or 0 \* 1/8" for the width (0 = multiplier).

For **Double cut** the desired waste area is set by entering a multiplier > 0; e.g width: 2 \* 1/6" (2 = multiplier). Thus in this case the waste area would be 2 \* 1/6" long. Any leftovers longer than this will automatically be chopped.

**Edge cut** can be set by entering cut width step = NO CUT.

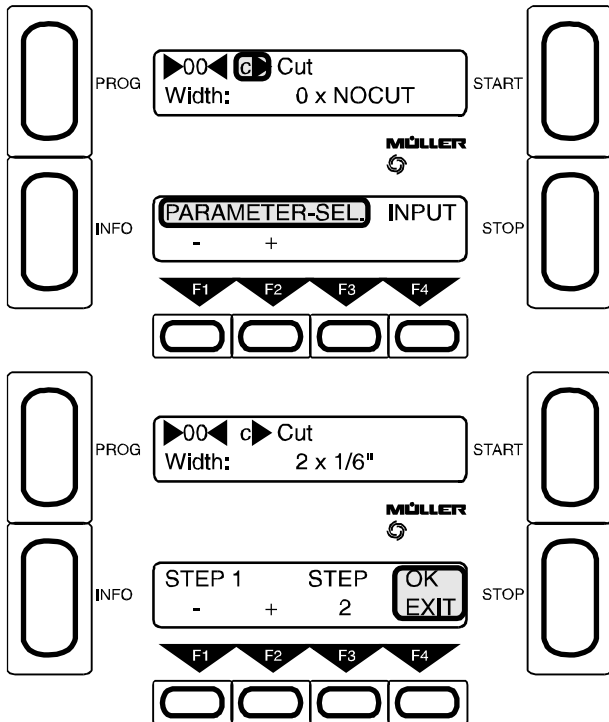

F4 - Press Input

F1 and F2 - Multiplier for cut width step (0-9)

F3 - Cut width step (NO CUT, 1/6", 1/8" or 1/24") (R)

z.B.: 0 x NO CUT = No cross cut  
 0 x 1/6" = Single cut  
 2 x 1/8" = Double cut (at the upper and the lower edge of the form 1/8" will be cut away)

Possible cuts:

No cross cut - only the margins will be cut away - Parameter c) 0 x NO CUT

Single cut  
 Parameter c) 0 x 1/6"  
 or 0 x 1/8"  
 or 0 x 1/24"

Double cut

The piece cut away can be min. 1/24", max. 1 1/2" wide and is distributed symmetrically on both sides of the perforation. Wider double cuts can be programmed using parameters i) and j).

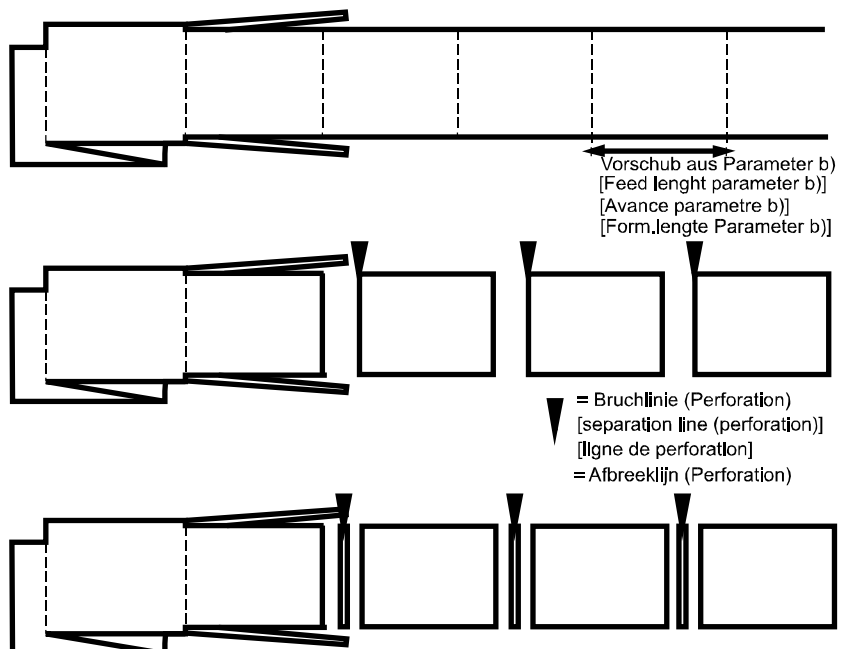

3.2.1.4 Parameter d) Counter

In this parameter a programmable counter can be preset. It is used if on reaching a given number of forms a function must be carried out which has been set in parameter e) **Counter Function**. In addition the SUB-counter (= group counter) and the ACT-counter (= actual) can be set at 00000.

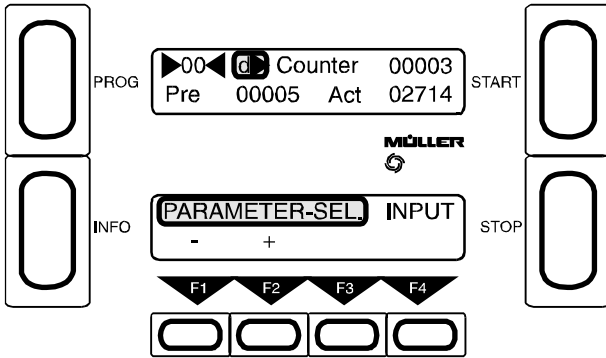

F4 - Press Input

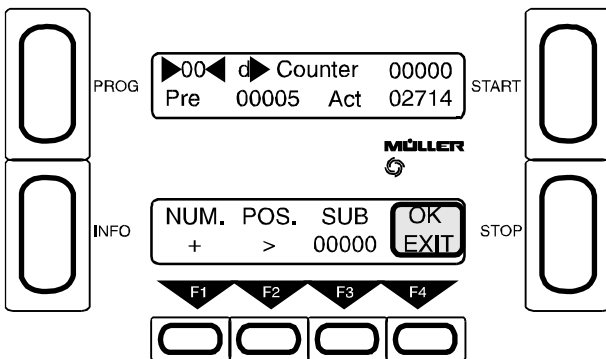

F1 - Select number (0-9) (R)

F2 - Current write position =\_ (R)

F3 - Set SUB-counter at 00000  
(first time F3 is pressed)

The SUB-counter is used for all operations with counter functions (except NONE).

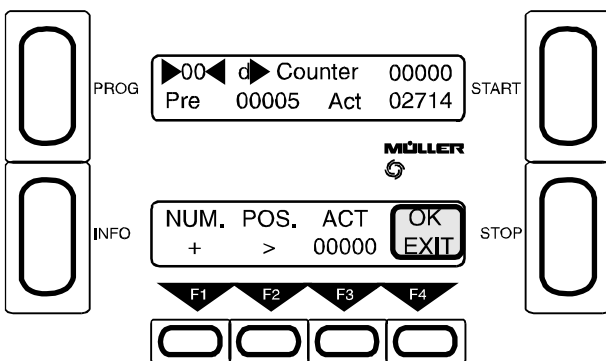

F3 - Set ACT-counter at 00000  
(second time F3 is pressed)

The ACT-counter can be used as a daily counter (or for a particular job).

F4 - Exit

### 3.2.1.5 Parameter e) Counter Function

The machine can carry out a **counter function** after reaching the number of forms preset in parameter d) **Counter**. Available functions are "NONE" - "STOP" - "CUT" - "ONLINE #00/#01" und "PAUSE".

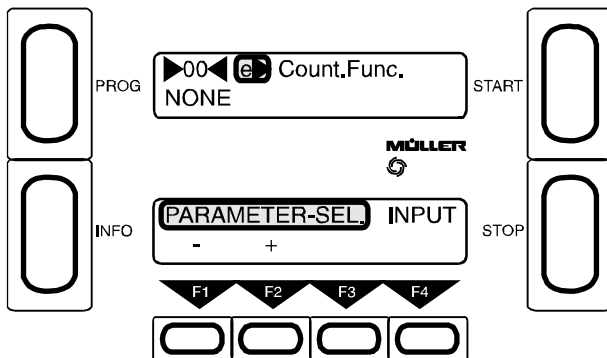

F4 - Press Input

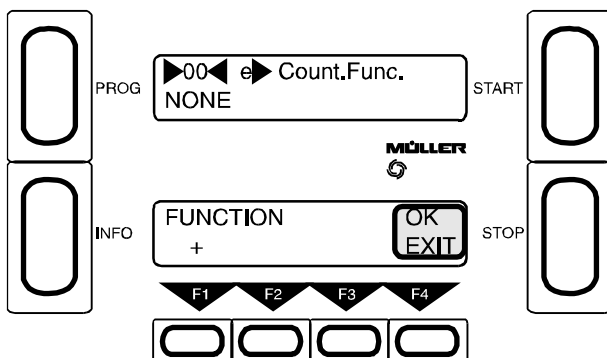

F1 - Select a function (R)

F4 - Exit

- NONE:** None of the functions listed below (the preset counter is not in use)
- STOP:** The machine stops on reaching the preset number (SUB-counter returns to 00000).
- CUT:** Edge cut only - a cross cut is carried out on reaching the preset number (SUB-counter returns to 00000).
- ONLINE #00/#01:** The preset counter can be programmed to output any online functions. **No** OMR system is required (i.e. no reading head). If this function is selected the reading head will be automatically dead. A maximum of 2 functions (3 with new software) can be performed, one function several times, the other once only (e.g. collecting and enveloping or selecting and enveloping). See Section 3.3.4.
- PAUSE:** Pause (~3 sec) after reaching the preset number (the SUB-counter returns to 00000). For manual removal or group separation with conveying belts.

3.2.1.6 Parameter m) Programming the fold length

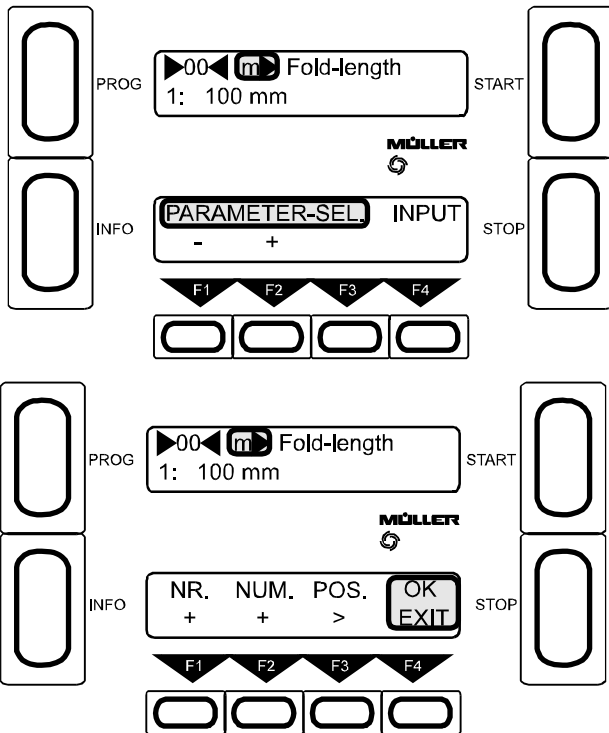

Button F4 - push enter

- F1** - Select Folder 1-4 (R)  
(The sequence 1-4 is equal to the set-up of the Folders in paperflow direction). Max. you can connect up to four Folders in line.
- F2** - Digit selection (0-9) (R)
- F3** - actual write position =\_ (R)
- F4** - End

The fold-length input is in mm (i.e. 100 mm).  
Fold length: min 50 mm, max. 231 mm

### .3 The programming level (level 2)

Access to the programming level is only possible when the machine is **switched off**. Press and hold down buttons **F1-F4** and **switch on** the machine. Buttons **F1-F4** can be released when the message OK appears on the lower display.

After the machine has been switched on the programmer can perform various functions. He can:

- perform all operator functions.
- **enter all parameters in program slot 00** and save the program in slots 01-83.
- browse through all parameters a) - m) in all programs (00 - 99).

A limited number of service functions are available

SERVICE	000	Return to program
	008	Input OMR routines
	078/079	Adjust brightness of display
	080-089	Select language
	104-107	For OMR process

#### 3.3.1 Selecting and altering parameters

##### 3.3.1.1 Parameter a) Label

The **Label** parameter can be used to input program labels or names (e.g. test program). The labels can be up to twenty characters long and have no effect on the function of the machine. They are intended only as an aid to finding programs. The label always appears during PROGRAM-SELECT.

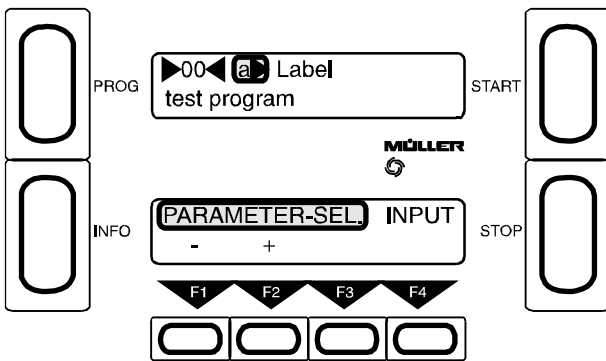

Taste F4 - Press Input

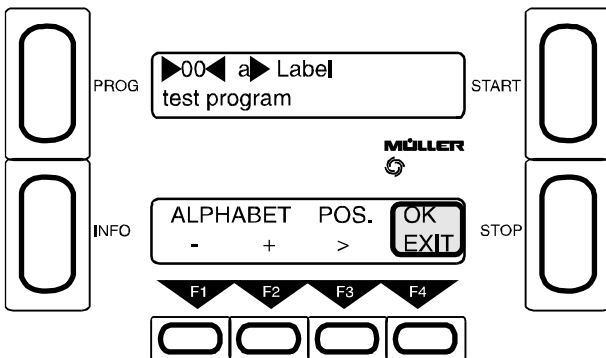

F1 and F2 - Select letters, numbers or special characters (turn page up or down) (R)

F3 - Current write position =\_ (R)

F4 - Exit

3.3.1.2 Parameter f) Speed

In the **Speed** parameter the feed rate can be altered from level 1-7 (level 7 = maximum speed).

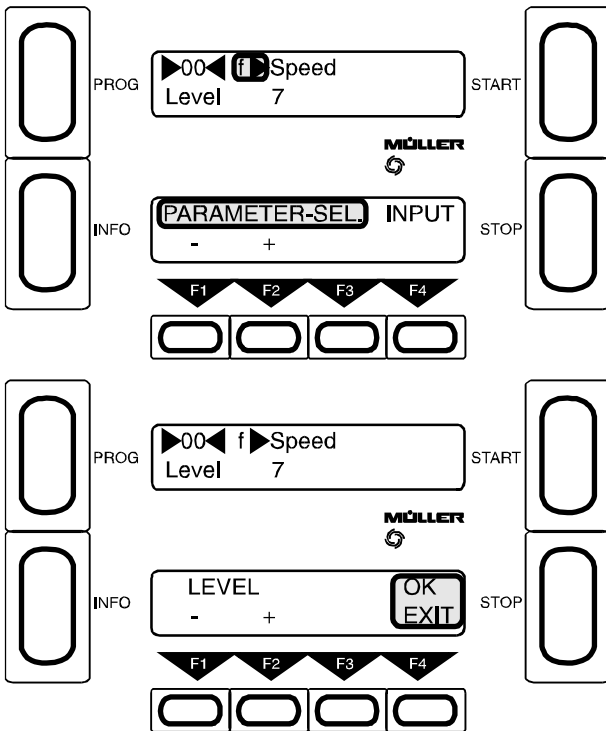

**F4** - Press Input

The speed can also be changed during continuous operation. The change will automatically be saved in the current program.

**F1 and F2** - Select level 1-7

**F4** - Exit

3.3.1.3 Parameter g) Pause

In the **Pause** parameter seven different pause intervals (after cutting) can be preset. The shortest interval is level 1 = 0,03 sec; longest interval is level 7 = 0.21 sec.

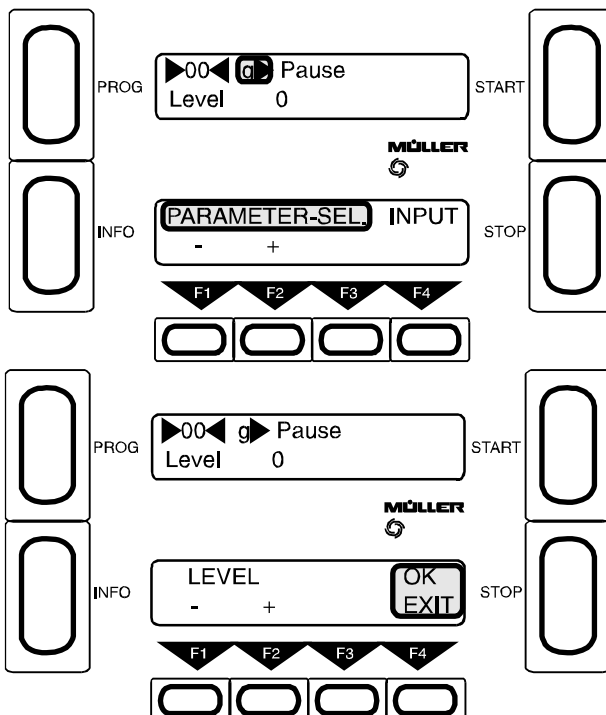

**F4** - Press Input

The pause interval can also be changed during continuous operation. The change will automatically be saved in the current program.

**F1 and F2** - Select level 0-7

**F4** - Exit



3.3.1.4 Parameter h) **Fine Position**

This parameter can be used for fine adjustment of the cross cut position. This is done in steps of 1/192". The cutting position can be adjusted to a maximum of 31/192" forward or reverse.

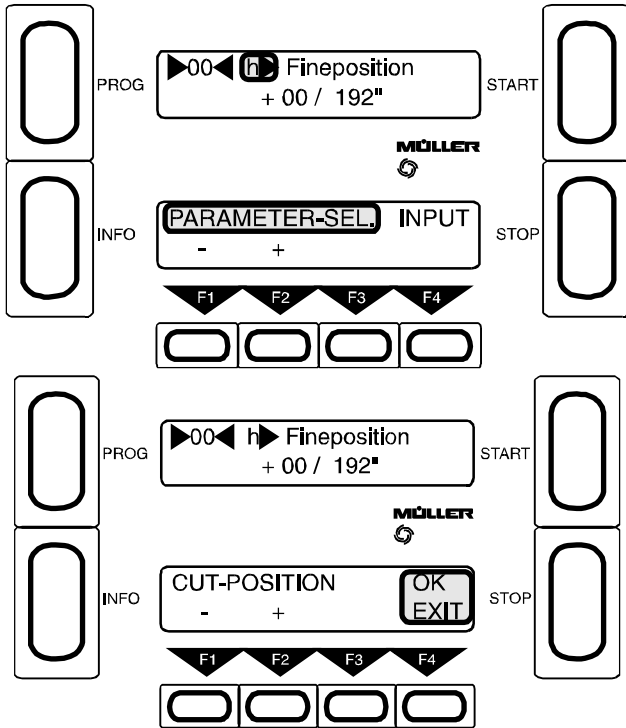

**F4** - Press Input

The fine position can also be changed during continuous operation. The change will automatically be saved in the current program.

**F1** - 1/192" reverse

**F2** - 1/192" forward

**F4** - Exit

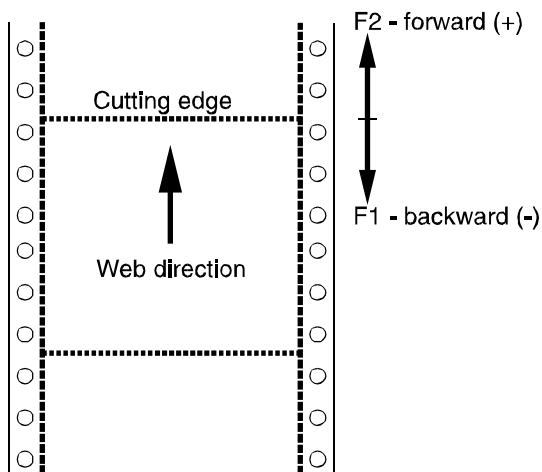

The paper is moved forwards in relation to the blade.

The paper is moved backwards in relation to the blade.

**F1** and **F2** can be used to adjust the cutting position during continuous operation.

3.3.1.5 Parameter k) **Reader**

Parameter k) is used to set whether or not an optical mark recognition (OMR) system is to be used, or whether the machine is to operate online-equipment. The OMR system reads marks (the code) on the form, each of which indicates a special function (e.g. collecting or enveloping). There are 6 OMR program slots. In each of these slots a complete OMR program can be entered. In addition the OMR routine for the function ONLINE #00/#01 can be set.

Key to numbers:

- 0 No OMR (neither the preset counter nor the reading head is active; no interface dialog will be carried out with on-line equipment)
- 1 Standard OMR routine (fixed program)
- 2-6 OMR programs which can be written by the user
- 7 Routine for cut at adjustment line
- 8 Reserved for special jobs
- 9 OMR routine for direct channel. The marks read by the forms cutter will be **evaluated** in some other system, e.g. the enveloping machine or the black box. All information detected is transmitted to the evaluating system without being processed.

If the OMR system is to be used, the adjustment line position (AL) should now be entered. The mark in the adjustment line is the first to pass under a reading head during scanning. As a rule this mark has no special function. When the marks are evaluated it serves only to enhance reading reliability.

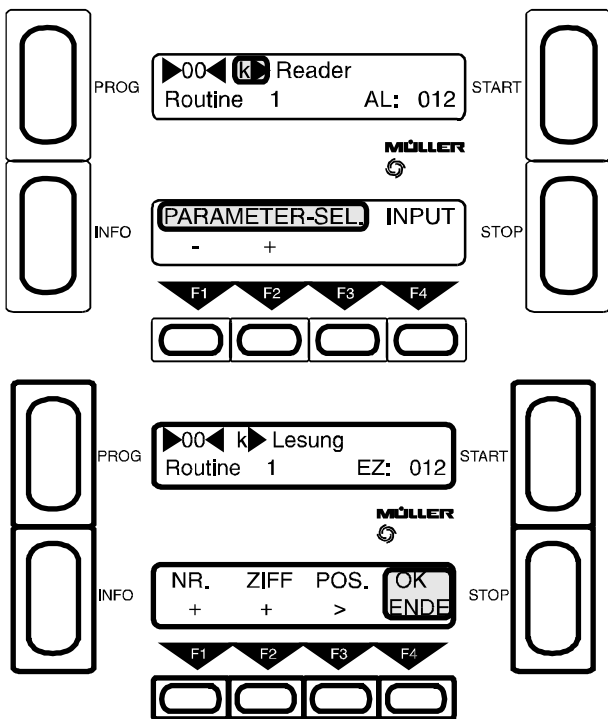

F4 - Press Input

- F1 - Select routine 0-9 (R)
- F2 - Select number (0-9) (R)
- F3 - Current write position = \_ (R)

F4 - Exit

AL - Adjustment line in this case is line 12 (line distance 1/6" or 1/8" is given in parameter b) Length)

For OMR programming see Section 3.3.2

### 3.3.1.6 Parameter I) Copy

Here you can copy **programs** from other program slots into the current program slot and save them.

Programs can only be entered or altered in program slot 00.

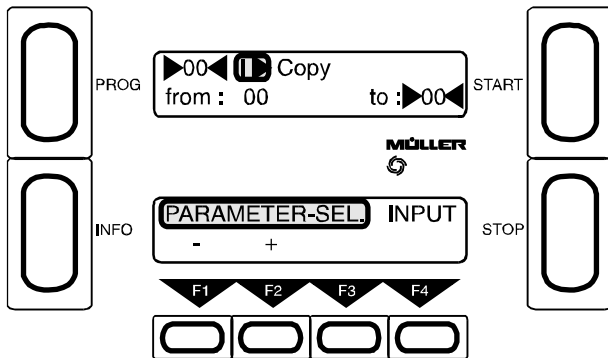

**F4** - Press Input

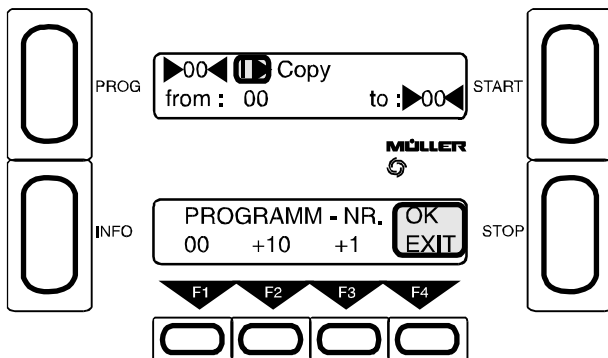

- F1** - Always goes to program slot 00
- F2** - Advances 10 program slots (R)
- F3** - Advances 1 program slot (R)
- F4** - Exit

Example:

A program that has been entered or altered in program slot 00 is to be stored in slot 30.

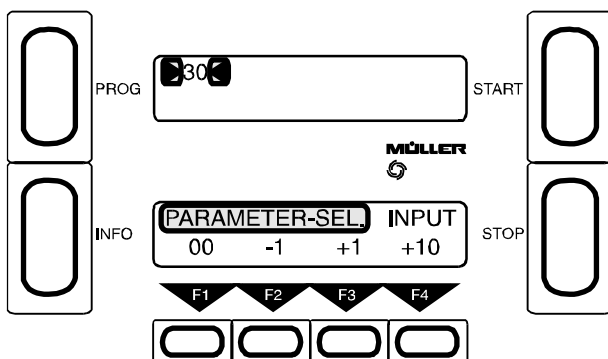

**F4** - Select program slot 30

Press **PROG** and select parameter I) **Copy** with **F1**

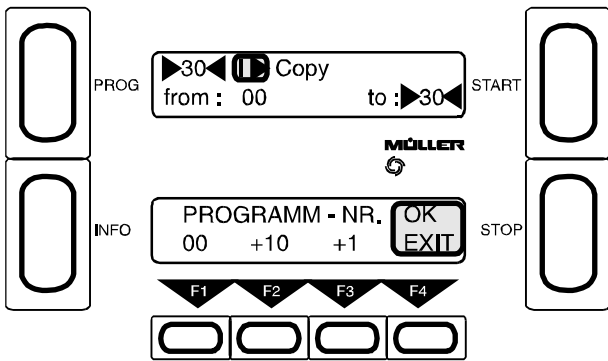

F1 - Select program slot 00

F4 - Exit

When F4 is pressed, the program is copied from program slot 00 into slot 30.

**Example:**

A program with the number 30 is to be altered. To do this, it has to be loaded in slot 00.

Before a program with a number between 01 and 83 can be altered, its parameters must first be copied into slot 00. The altered program is then recopied into its original slot. It is not possible to copy programs into slots 84-99. Every time the machine is switched on, fixed programs from the EPROM memory overwrite program slots 84-99.

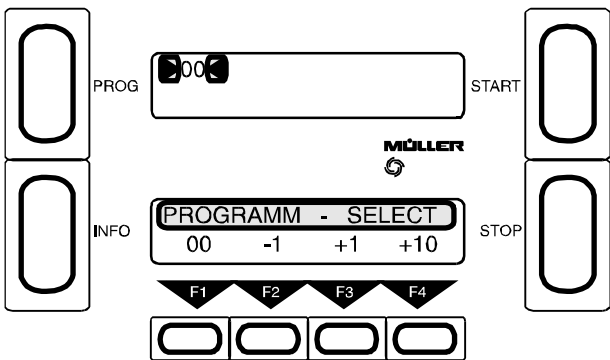

F1 - Select program slot

Press **PROG**

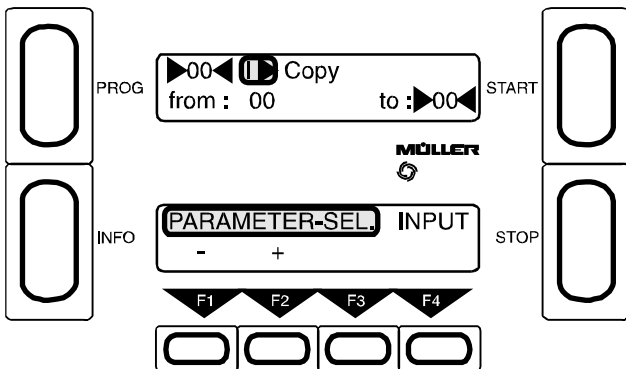

F1 - Select parameter I) Copy

F4 - Input

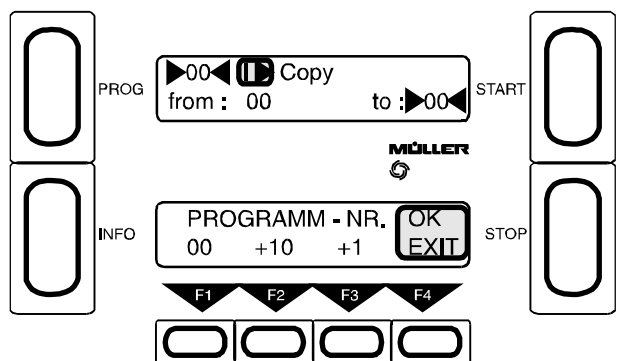

F2 - At "from" enter 30

F4 - Exit

When F4 is pressed the program is copied from 30 to 00.

The alterations can now be carried out.

### 3.3.2 Programming the OMR routines

In Section 3.3.1.5, parameter k) **Reader** you were able to select and execute the desired OMR program. If you wish to enter or compile your own programs, you can use OMR programs 2-6. Before you can enter a program, the adjustment line must be entered under **parameter k)**.

After accessing the programming level, press INFO and then PROG to get into the service routines. Here you can program the reader. Carry out the following steps in the given order:

1. Select and start service no. 008.
2. Select an OMR routine (1-6).
3. Select the running function allocation number (#00-#32)
4. Reading the OMR marks:  
You must enter a 5-digit decimal number for the pattern of marks (code).
5. Allocating functions:  
Enter a 5-digit decimal number for the desired online output (equipment to be activated).

#### 3.3.2.1 Explanation of terms relating to optical mark recognition (OMR)

There are a number of terms relating to the OMR system which should be known to the user and which will be frequently used.

**Form length:** Form length always refers to the **uncut** form. This "real" length must be entered in parameter b) to avoid producing form length errors.

**Print lines:** Line feed in the computer printer can be in steps of  $\frac{1}{8}$ " or  $\frac{1}{6}$ ". The normal step is  $\frac{1}{6}$ ". The print lines are counted from the top of the form downwards in the direction of feed. Thus the top line is line 1 (with 12" forms the bottom line is 72). For technical reasons OMR marks may **not** be printed in the following lines: (see illustration page 30)  
- in lines 1 and 2 (begin at  $\frac{3}{6}$ " )

Notice: From software release ...10/96 onwards OMR marks can also be printed in line 30-33 (=  $\frac{30}{6}$ " -  $\frac{33}{6}$ " ). This was not possible with former software.

**Reading marks:** The reading marks are printed by the computer printer and should consist of two underlines next to each other. The underline gives the most reliable results. Two directly joined underlines are best, since in most cases the tractors of the printer are moved sideways by the computer operator during printing. If only one underline is used, there is a risk that the reading head will not be able to detect it. The mark passes to the side of the reading head and a reading error occurs.

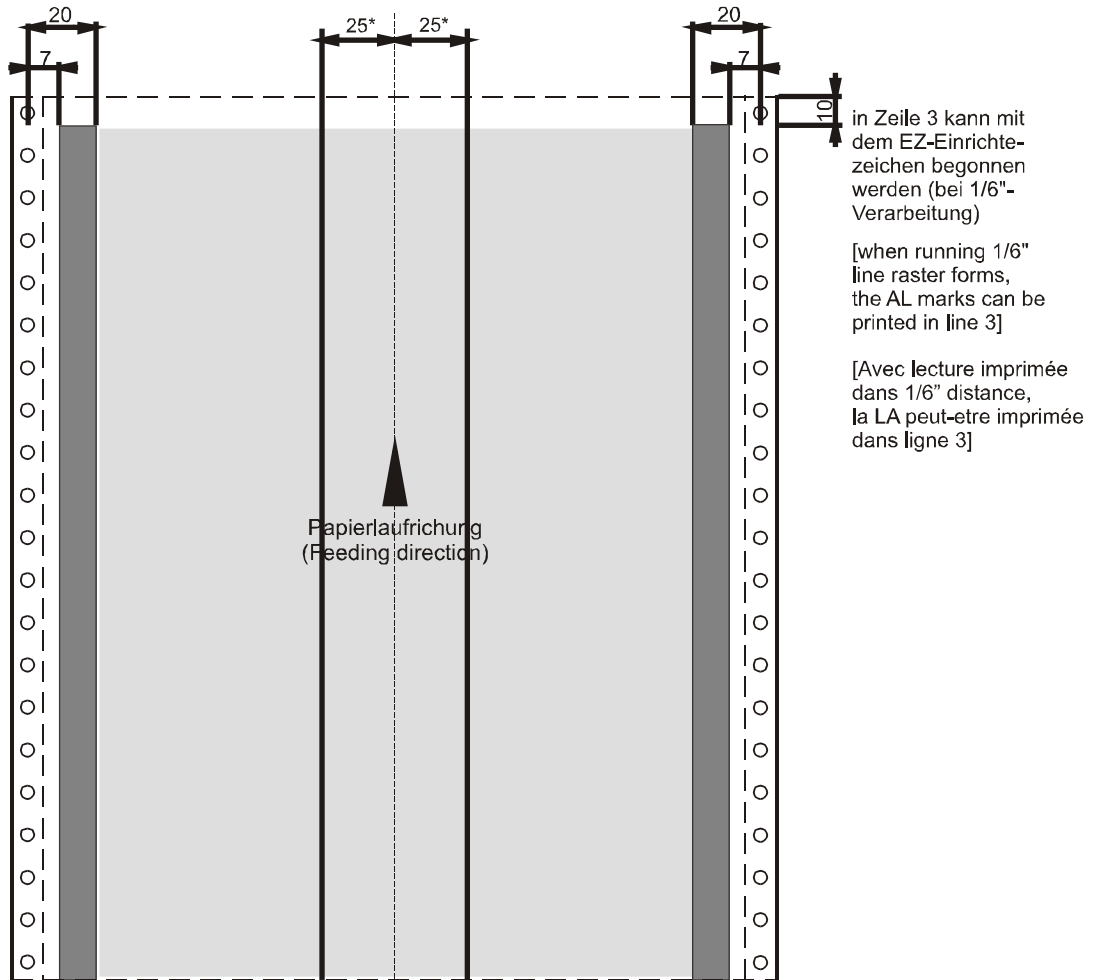

Lesebereich Links/Rechts  
[scanning range left/right]  
[Position de lecture droit/gauche]

Lesebereich Mitte [scanning range centre]  
\* Bei Papierbreite > 450 mm kann in diesem Bereich nicht gelesen werden.  
\* In this area OMR marks can not be read if form width > 450 mm.  
\* Dans cette position il n'est pas possible de lire quand le largeur du feuille est > 450mm

Größe und Stärke des Lesezeichen:  
[Size and thickness of the OMR-marks:]  
[Largeur et épaisseur des OMR-marques:]

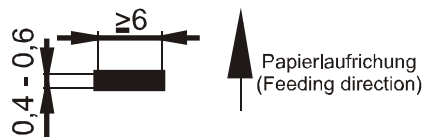

**Hinweis:** Lesezeichen NICHT auf die Perforation drucken!

**Please note:** Do NOT print reading marks on the perforation!

**Attention:** n' imprimez pas les marques sur la perforation

**Adjustment line (AL):** The adjustment line contains the first mark to pass under the reading head. As a rule **no** function is allocated to this mark. It serves to enhance reliability in evaluating the marks (codes), and also in adjusting the position of the reading head. The position of the adjustment line should be given in parameter k).

**Read area:** The read area is the area on the paper within which the reader is active. The adjustment line contains the first mark to be processed by the reading program. Sixteen lines are evaluated including the adjustment line - adjustment line plus 15. Through the allocation of codes the machine knows in which lines the marks are to be evaluated. Other marks are ignored by the machine.

In other words: as soon as lines (except the adjustment line) are linked to a function (through the programming of the OMR routine), marks which are printed on these lines will be evaluated. All other lines, e.g. text lines, will be treated as not belonging to the reading code system.

**Direct channel:** Routine 9, parameter k) is intended for applications in which marks read by the feeder are evaluated in the enveloping machine or some other system (black box). In this direct channel routine, the whole code from the adjustment line onwards is transmitted via the interface data line to the evaluating system (blackbox). The code is transmitted in its entirety without any further processing (code = functions).

**Code:** A 5-digit decimal number which corresponds to the pattern of marks.

**Function:** A 5-digit decimal number which is transmitted to online equipment via the interface. It contains (binary) information which triggers a particular function, e.g. collecting or selecting.

#### Read errors:

Read error: the code that has been detected is shown in the lower window on the display. The first read mark (always the AL) is shown on the display on the right (beside the arrow). The reading code is shown on the display from the right to the left. For example 0000000010 01001 (together 16 reading lines) means that in line 1 (=AL), 4 and 7 a reading mark was detected. No reading marks are printed in the remaining lines.

Read errors can have a variety of causes:

- a) The reading head and the mark are not on the same track.
- b) The reading head has not been correctly adjusted to the adjustment line in the direction of feed of the form.
- c) During printing the operator has moved the paper in the printer sideways or lengthways.
- d) Read errors may occur if the marks are printed with a coloured ribbon that uses a black which the infrared reading head cannot recognise as black (aniline dyes).
- e) Sensitivity level not correctly set. Can be altered under service routines 060-063.

060 OMR sensitivity level 0 000 low sensitivity  
 061 OMR sensitivity level 1 001  
 062 OMR sensitivity level 2 002  
 063 OMR sensitivity level 3 003 high sensitivity

000 = low sensitivity (recommended for **90% of all applications**)

Can be rechecked in service routine 009 (2/F). The new sensitivity level will be transferred only when the machine is switched on again.

f) The pattern of marks (code) does not exist in the list of routines selected under parameter k). Either the code is wrong or there may be dirt on the paper.

g) The marks are too faint. The ribbon should have been changed earlier.

3.3.2.2. Entering the 5-digit number for the position of marks (code)

A 5-digit **code** number is entered which indicates exactly in which lines the reading head is to search for the marks.

Table 1 can be used to convert the position of marks (code), which consists of the adjustment line (AL) plus a number of OMR marks, into a 5-digit number (**code**). Each code number represents a complete information unit.

The 5-digit code number is always made up of the adjustment line plus one or more other marks.

Here is an example to show how to enter the 5-digit number:

**Example 1:** In the equipment illustrated on page 33, six forms are to perform six different functions (this program is stored as a fixed program in OMR routine 1): **deflector unit 1, 2, 3, collector, enveloping and stop.**

Each form (see page 37) must contain the relevant **code** which gives the commands. The code always consists of the **adjustment line (AL)** and one or more other **marks**. The **reading head** detects the marks and passes on the functions information. In example 1, the form will now be sent to **deflector unit 1** if the mark is printed in the third line. The equipment will **stop** if the mark is printed in the seventh line after the AL, and so on.

Conversion Table 1: Convert code into 5-digit number

Mark in read area	5-digit number	Mark in	Example 1	Example 2
1	00001 = is always the AL	1	Adjustment line	Adjustment
2	00002	2	Deflector unit 2	Deflector unit
3	00004	3	Deflector unit 1	Deflector unit 1
4	00008	4	Collector	Collector
5	00016	5	Enveloping	Enveloping
6	00032	6	Deflector unit 3	
7	00064	7	Stop	
8	00128	8		
9	00256	9		
10	00512	10		
11	01024	11		
12	02048	12		
13	04096	13		
14	08192	14		
15	16384	15		
16	32768	16		



The 5-digit code number for enveloping and AL is thus 00017. Let us now consider the whole block of marks as a complete unit. The adjustment line contains the first mark, since it is the first to pass the reading head. Deflector unit 2 is thus the second mark, and so on. We can use Table 1 to find the appropriate 5-digit code number for any combination of marks. In example 1 these are:

- 1. AL + Collector = 00009
- 2. AL + Enveloping = 00017
- 3. AL + Deflector unit 1 = 00005
- 4. AL + Deflector unit 2 = 00003
- 5. AL + Deflector unit 3 = 00033
- 6. AL + Stop = 00065

When entering the above code numbers make sure that the positions are entered in the OMR routine in ascending order. A maximum of 33 positions can be entered.

In our example six positions have been filled by entering all the combinations that occur. In order for the machine to work correctly, the remaining positions in this routine must also be filled with the command **Fill up** (from #06 - #31).

The 5-digit code numbers worked out using this method are entered under "Code" when programming the reader. In **example 1** input should be carried out as follows (input for the function is described below):

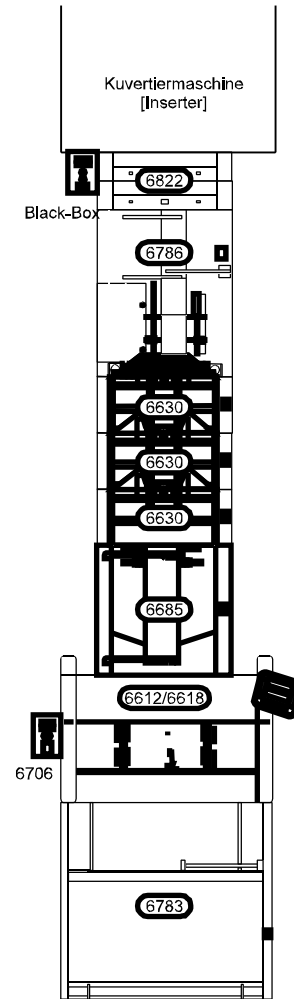

**OMR Routine 1 #00**  
Code 00017 Fnc. 00001

**OMR Routine 1 #01**  
Code 00009 Fnc. 00002

**OMR Routine 1 #02**  
Code 00005 Fnc. 00004

**OMR Routine 1 #03**  
Code 00003 Fnc. 00003

**OMR Routine 1 #04**  
Code 00033 Fnc. 00010

**OMR Routine 1 #05**  
Code 00065 Fnc. 32708

Unoccupied positions in a list should be filled using the command **Fill up**.

**Example 2:** The same 6 functions as in example 1 are to be carried out: **deflector unit 1,2,3, collector, enveloping and stop.**  
 In order to limit the number of lines to be read, it is also possible to allocate one function to several marks.  
 E.g. If there is a mark in lines 2 and 3 at the same time, the form should be sent to deflector unit 3 (see illustration p. 38)

Where several marks are to be used, the 5-digit code number is worked out by adding them together. Thus the number for deflector unit 2 + deflector unit 1 + AL = 2 + 4 + 1 = 7.  
 The 5-digit code number for enveloping and AL is thus 00017. Let us now consider the whole block of marks as a complete unit. The adjustment line contains the first mark, since it is the first to pass the reading head. Deflector unit 2 is thus the second mark, and so on. We can use Table 1 to find the appropriate 5-digit code number for any combination of marks. In our example these are:

1.	AL	+	collector	=	00009
2.	AL	+	enveloping	=	00017
3.	AL	+	deflector unit 1	=	00005
4.	AL	+	deflector unit 2	=	00003
5.	AL	+	deflector unit 3	=	00007
6.	AL	+	stop	=	00025

In **example 2** input should be carried out as follows  
 (input for the function is described below):

In position #32 it is possible to output one or more functions for forms which have caused **areading error**. The

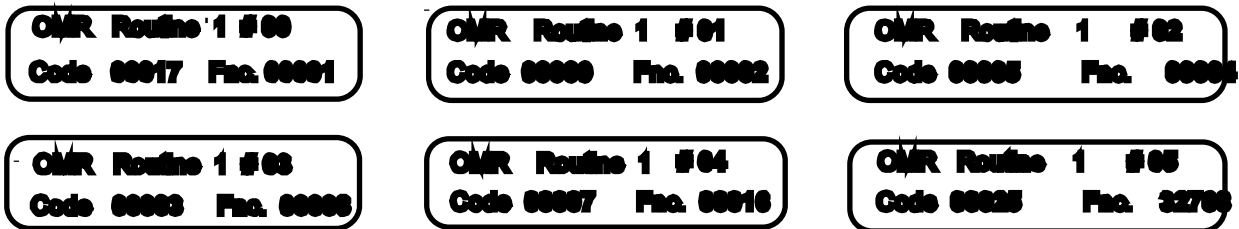

function "select" is recommended, if there is a deflector unit available. The "Code" column in line 32 is here always 00000. In the "Function" column one or more functions can now be entered (as in numbers #00 - #31). See also the function tables. If a read error occurs, i.e. none of the codes in #00 - #31 is recognised as valid, then the function given in line #32 will be output for the form which caused the reading error. The machine will be stopped and "read error" will appear in the display.

Suggestion for function in line #32: Deflector unit 1 = 5-digit number 00004  
 The 5-digit number for the code remains 00000

3.3.2.3 Entering the 5-digit number for the functions

We shall now allocate a **function** to the marks on the form which are to be detected by the reading head. Table 2 (page 35) for converting functions (Fnc) into 5-digit numbers is used in the same way as Table 1. Each combination of marks represents one or more functions. To go back to our examples, we have here six different functions (enveloping, collector, deflector unit 1, deflector unit 2, deflector unit 3 and stop). **Müller online machines have fixed functions!**  
 Input for the function is described in the examples above.

OMR data list

1 - 00001 = AL  
 2 - 00002 =  
 3 - 00004 =  
 4 - 00008 =  
 5 - 00016 =  
 6 - 00032 =  
 7 - 00064 =  
 8 - 00128 =  
 9 - 00256 =  
 10 - 00512 =  
 11 - 01024 =  
 12 - 02048 =  
 13 - 04096 =  
 14 - 08192 =  
 15 - 16384 =  
 16 - 32768 =

00001 - Insert  
 00002 - Accumulator Conveyor  
 00004 - Deflector unit I  
 00008 - Deflector unit II  
 00016 - Deflector unit III  
 00032 - Deflector unit IV  
 00064 - Selective enclosure  
 00128 - Selective enclosure  
 00256 - Traversal transport opposite direction  
 00512 - Traversal accumulator opposite direction  
 01024 - Traversal transport split drive (2-up)  
 02048 - user free  
 04096 - user free  
 08192 - user free  
 16384 - deflect complete group  
 32768 - STOP

P.S.:  
 Beginning from the last PIN  
 fill the rest lines with function  
 F 3 "Fill up".

	Code																Function	Description		
# 00	X			X													17	X	1	End of collation (EOC)
# 01	X		X														9	X	2	Accumulate
# 02	X	X															5	X	4	Deflector unit 1
# 03	X	X															3		8	Deflector unit 2
# 04	X	X	X														7		16	Deflector unit 3
# 05	X		X	X													25		X	32768 STOP
# 06	X	X	X														11		X	16384 Deflect complete group
# 07	X	X																		
# 08	X	X																		
# 09																				
# 10																				
# 11																				
# 12																				
# 13																				
# 14																				
# 15																				
# 16																				
# 17																				
# 18																				
# 19																				
# 20																				
# 21																				
# 22																				
# 23																				
# 24																				
# 25																				
# 26																				
# 27																				
# 28																				
# 29																				
# 30																				
# 31																				
# 32	NC OME - code										00000									

Application: Reading Routine 1  
Fixed Program

Examples for read error	00000	STOP only
	00004	Deflector Unit I
	00256	Traversal Transport
	00513	Traversal Accumulator

Data-form OMR-reading  
 for Automatic Forms Cutter  
 6610/6611/6612

Reading Routine 1 Page: \_\_\_\_\_

Date: \_\_\_\_\_

Conversion Table 2: Convert function into 5-digit number

Function (Fnc) 5-digit number	Müller online equipment to be activated
00001	End of group, enveloping, stapling, eject
00002	Collect (Accumulator)
00004	Deflect (Deflector Unit 1), see a)
00008	Deflect (Deflector Unit 2), see a)
00016	Deflect (Deflector Unit 3), see a)
00032	Deflect (Deflector Unit 4), see a)
00064	Free (e.g. selective)
00128	Free (e.g. selective)
00256	Change direction (cross transport)
00513	Change direction (Transversal Accumulator), see b)
01024	Dual action (cross transport)
02048	Group will be stapled if digi-switch for staple reverse in staple module 6760/6766 is set at position 5,6,7.
04096	Free
08192	Free
16384	Block Deflection, see a)
32768	Stop

## a) Block Deflect:

Block Deflection can be performed by any Müller 6630 deflector unit. The hinged cover of the first deflector unit after the cutting machine is opened by function 16384 and stays open until function 00001 = End of group is recognised. In the same way, cross transport 6691 and block Deflection (function 16384) are activated until End of group (function 00001).

## b) Transversal Accumulator:

For the Transversal Accumulator, function 00513 is: Eject group from machine. (00512 for Change direction + 00001 for Eject).

## c) Stream stacking:

Lengthwise group separation is obtained with function 00003 (00002 + 00001).

## d) Cut at mark:

If you wish the machine to make a cut at a particular mark, first select OMR routine 7 and enter the definition for the adjustment line "AL" (the "AL" triggers cutting).

To program the OMR routine you must:

1. be in the programming level (Section 3.3).
2. program parameter k) **Reader**.
3. change into the service routine by pressing INFO and then PROG.
3. select and start service no. **008**.

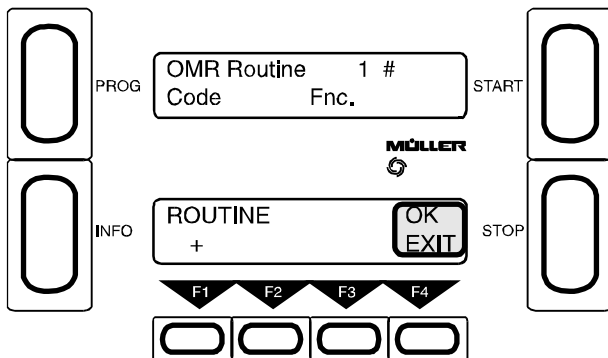

**F1** - Select a routine 1-6 (R)

- 1 Standard OMR routine (fixed program)
- 2-6 OMR programs which can be written by the user

**F4** - Exit

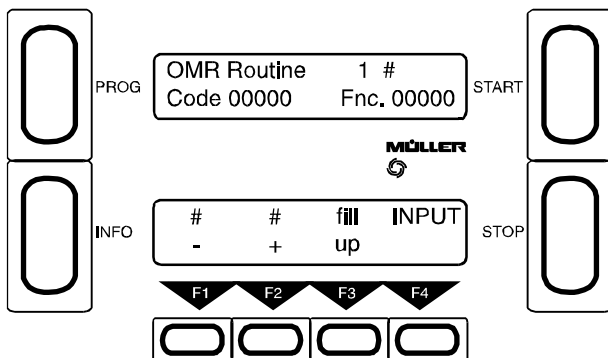

**F1** and **F2** - Select a position #00-#32 (R)

**F3** - Fill up the remaining positions.  
(Code 00000 is not permitted in the OMR routine. This is so that if, for example, the machine does not recognise a mark it will stop and show a reading error.)

**F4** - Input

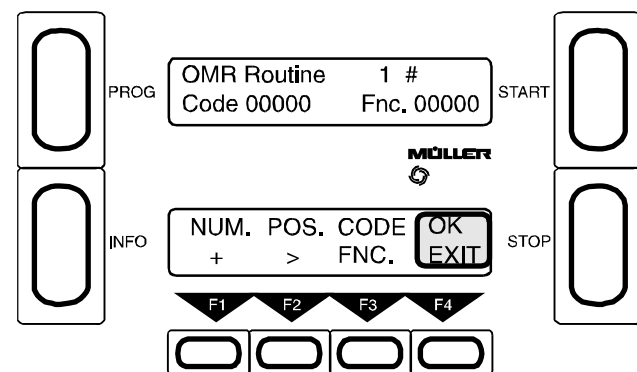

**F1** - Select number (0-9) (R)

**F2** - Current write position = (R)

**F3** - Select CODE or FNC.

**F4** - Exit

To return to program press the **Prog**-button twice and call Service Nr. 000.

**Example 1:**

—	Adjustment line
—	Deflector unit 2
	Deflector unit 1
	Collector
	Enveloping
	Deflector unit 3
	Stop
	Free
	Free
	Free
	Free
	Free
	Free
	Free
	Free
	Free
	Free

List 1: Deflector unit 2

—	Adjustment line
	Deflector unit 2
—	Deflector unit 1
	Collector
	Enveloping
	Deflector unit 3
	Stop
	Free
	Free
	Free
	Free
	Free
	Free
	Free
	Free
	Free
	Free
	Free

List 2: Deflector unit 1

—	Adjustment line
	Deflector unit 2
	Deflector unit 1
—	Collector
	Enveloping
	Deflector unit 3
	Stop
	Free
	Free
	Free
	Free
	Free
	Free
	Free
	Free
	Free
	Free

List 3: Collector

—	Adjustment line
	Deflector unit 2
	Deflector unit 1
—	Collector
	Enveloping
	Deflector unit 3
	Stop
	Free
	Free
	Free
	Free
	Free
	Free
	Free
	Free
	Free
	Free

List 4: Enveloping

—	Adjustment line
	Deflector unit 2
	Deflector unit 1
	Collector
	Enveloping
—	Deflector unit 3
	Stop
	Free
	Free
	Free
	Free
	Free
	Free
	Free
	Free
	Free
	Free

List 5: Deflector unit 3

—	Adjustment line
	Deflector unit 2
	Deflector unit 1
	Collector
	Enveloping
	Deflector unit 3
—	Stop
	Free
	Free
	Free
	Free
	Free
	Free
	Free
	Free
	Free
	Free
	Free

List 6: Stop

**Example 2:**

——	Adjustment line
——	Deflector unit 2
	Deflector unit 1
	Collector
	Enveloping
	Free
	Free
	Free
	Free
	Free
	Free
	Free
	Free
	Free
	Free
	Free
	Free

List 1: Deflector unit 2

——	Adjustment line
	Deflector unit 2
——	Deflector unit 1
	Collector
	Enveloping
	Free
	Free
	Free
	Free
	Free
	Free
	Free
	Free
	Free
	Free
	Free
	Free

List 2: Deflector unit 1

——	Adjustment line
	Deflector unit 2
	Deflector unit 1
——	Collector
	Enveloping
	Free
	Free
	Free
	Free
	Free
	Free
	Free
	Free
	Free
	Free
	Free
	Free

List 3: Collector

——	Adjustment line
	Deflector unit 2
	Deflector unit 1
	Collector
——	Enveloping
	Free
	Free
	Free
	Free
	Free
	Free
	Free
	Free
	Free
	Free
	Free
	Free

List 4: Enveloping

——	Adjustment line
	Deflector unit 2
	Deflector unit 1
——	Collector
——	Enveloping
	Free
	Free
	Free
	Free
	Free
	Free
	Free
	Free
	Free
	Free
	Free
	Free

List 5: Deflector unit 3

——	Adjustment line
	Deflector unit 2
	Deflector unit 1
	Collector
——	Enveloping
——	Free
	Free
	Free
	Free
	Free
	Free
	Free
	Free
	Free
	Free
	Free

List 6: Stop

OMR data list

#	Code	Function	Explanation
# 00			
# 01			
# 02			
# 03			
# 04			
# 05			
# 06			
# 07			
# 08			
# 09			
# 10			
# 11			
# 12			
# 13			
# 14			
# 15			
# 16			
# 17			
# 18			
# 19			
# 20			
# 21			
# 22			
# 23			
# 24			
# 25			
# 26			
# 27			
# 28			
# 29			
# 30			
# 31			
# 32	Code combination not possible	00000	
Job: _____			
		Example for read errors	
		00000	Stop only
		00004	Deflector unit
		00256	Traversal Transport
		00513	Traversal Accumulator

P.S.:  
Beginning from the last PIN  
fill the rest lines with function  
F 3 "Fill up".

1 - 00001 = AL  
 2 - 00002 =  
 3 - 00004 =  
 4 - 00008 =  
 5 - 00016 =  
 6 - 00032 =  
 7 - 00064 =  
 8 - 00128 =  
 9 - 00256 =  
 10 - 00512 =  
 11 - 01024 =  
 12 - 02048 =  
 13 - 04096 =  
 14 - 08192 =  
 15 - 16384 =  
 16 - 32768 =  
 00001 - Group end  
 00002 - Accumulator  
 00004 - Deflector unit I  
 00008 - Deflector unit II  
 00016 - Deflector unit III  
 00032 - Deflector unit IV  
 00064 - open (selectiv)  
 00128 - open (selectiv)  
 00256 - Traversal-transport change of direction  
 00512 - Traversal-accumulator change of direction  
 01024 - Traversal-transport two-up  
 02048 - free  
 04096 - free  
 08192 - free  
 16384 - block outsourcing  
 32768 - STOP

Data-form OMR-reading \_\_\_\_\_ Date: \_\_\_\_\_  
 for Automatic Forms Cutter 6610/11/12 Read routine \_\_\_\_\_ Page: \_\_\_\_\_



### 3.3.3 Counter function ONLINE # 00 / # 01

The preset counter can be programmed to output anyonline functions. No OMR system is required (i.e. no reading head). The reading head is automatically dead. Two or three functions can be carried out, one function several times, the other(s) only once.

First the following information must be entered in the **programming level**:

1. Set the preset counter under parameter **d) Counter**.
2. Enter the function ONLINE #00/#01 under parameter **e) Counter function**.
3. Change into the **service routine** by pressing **INFO** and then **PROG**:

**Service nr. 096:** 2 Online functions (installed).

**Service nr. 097:** 3 Online functions (select when needed).

4. Select **service nr. 008** and program the routine.

In an OMR routine desired functions are programmed in the first two lines # 00 / # 01 of the list (input in the CODE column is of no significance).

#### 2 ONLINE functions

The machine carries out the function entered under line #01 until the number before the preset number on the counter is reached. On reaching the preset number, the machine carries out the function entered under line #00. At the same time the actual counter returns to 00000.

#### Example:

Example: In **OMR program 2, three forms** are to be **collected and enveloped**.

1. Select **service no. 008** and enter OMR routine 2.
2. Press **F4**.
3. In line # 00 enter 00001 (enveloping) for the function.
4. Use **F3** to switch between **Code** and **Fnc**.
5. In line # 01 enter 00002 (collect) for the function.

To return to program press the Prog-button twice and call service nr. 000.

Routine 2	Code	Function	
# 00	00000	00001 (enveloping)	Sheet 00003
# 01	00000	00002 (collect)	Sheets 00001 to 00002

The program can be saved in any program slot from 01-84. The counter (PRESET + ACTUAL) can be changed from programs 00-84.

**Special cases:** Preset 00001 - the function in # 00 will always be output.  
Preset 00000 - the function in # 01 will always be output.

### 3 ONLINE functions

The machine carries out the function entered under line #01 until **two** numbers before the preset number on the counter is reached. Then the machine once carries out the function entered under line # 02. On reaching the preset number, the machine once carries out the function entered under line #00. At the same time the actual counter returns to 00000.

Example: In **OMR program 2**, **four forms** are to be **collected** and **enveloped**, **one form** will be **deflected**.

Routine 2	Code	Function	
# 00	00000	00004 (deflect)	Sheet 00005
# 01	00000	00002 (collect)	Sheets 00001 to 00003
# 02	00000	00001 (enveloping)	Sheet 00004

### 3.4 The technician level (level 3)

Access to the technician level should be restricted to trained service technicians only.

In order to access the technician level the machine must first be **switched off**. Then switch the machine on while holding down buttons **F1-F4**. When OK appears in the display, press **INFO** once. Then release **F1-F4**.

To get into the service routines press **INFO** and then **PROG**.

The technician has all the service facilities at his disposal.

When the machine is switched off, it returns automatically to the operator level.

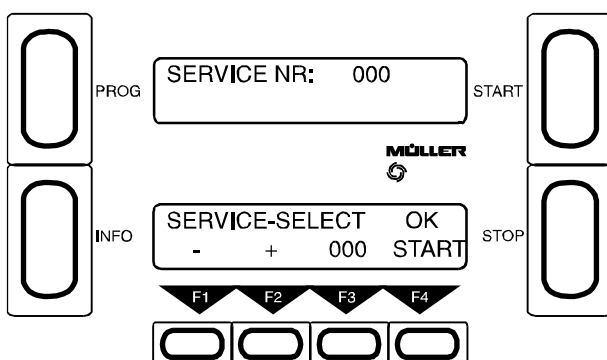

**F1** and **F2** - Move one service no. up or down (R)

**F1** and **F2** together - Move fast through the service nos.

**F3** - Select service no. 000

**F4** - Start the selected service routine

**3.4.1 Service routines**

The service routines can only be called from the following software version onwards:  
 Central computer chip "H ..... 46/92" ("H 133") and display chip "D ..... 05/93"

Service routine no.	Function	Display when a service routine is started	Comments																																																																																
000			Return to user program																																																																																
008	OMR routines program		program own routine																																																																																
009 1)	ID chip data		<table border="1" style="width: 100%; text-align: center;"> <tr> <td><sup>0</sup> A B</td> <td><sup>1</sup> C D</td> <td><sup>2</sup> EFGH</td> <td><sup>3</sup> IJKL</td> <td><sup>4</sup> M</td> <td><sup>5</sup> NOPQ</td> </tr> <tr> <td>- +</td> <td>- +</td> <td>- +</td> <td>- +</td> <td>- +</td> <td>- +</td> </tr> </table> <p>0,1,2,3,4,5 = running numbers of levels (use the - + buttons to move one level up or down). A = control no., B + C = serial no. (e.g. B = 00001, C = 04465, serial no. = 14465), D = model no., E = fine correction, F = reading sensitivity, G = calendar week, H = year, I = DA value 1, J = DA value 2, K = DA value 3, L = DA value 4, M = cutting cycles, see table N+O below, P=Doublecut Increase. DA values are correcting variables output by the computer to correct deviations in the electronic system. After automatic adjustment (service 10) the DA values must not be greater than 200.(for further information see pt. 4.4.). An error message (31,32,33,34) will appear in the display for values above 250. The machine can only be started after the error has been corrected. Examples of possible errors are: distance between scanner head and encoder disk, fibre-optic plug not plugged in, dirt on the encoder disk. DA value 1,2 = scanner head - cross cutter, DA value 3,4 = scanner head - tractor.</p> <p>The display valves N+O will show ID-valves from 000 to 255 (=1 Byte) consisting of 8 Bits. The valve results in the binary addition of selected service numbers. Example: All service routines of the leftside are set: result = 000. If service 69,67,65,75 is set (right side ID valves 1+2+4+8) and service 76,96,38 is set, the result = 015.</p> <p>Table for display N:</p> <table border="1" style="width: 100%; text-align: center;"> <thead> <tr> <th>ID-Value</th> <th>Service-Nr.</th> <th>ID-Value</th> <th>Service-Nr.</th> </tr> </thead> <tbody> <tr> <td>000: START/STOP possible</td> <td>68</td> <td>001: START/STOP not possible</td> <td>69</td> </tr> <tr> <td>000: eject last sheet</td> <td>66</td> <td>002: no paper ejection</td> <td>67</td> </tr> <tr> <td>000: no match code</td> <td>64</td> <td>004: Match code output dir.</td> <td>65</td> </tr> <tr> <td>000: fine pos. normal</td> <td>74</td> <td>008: Finepos. * 2</td> <td>75</td> </tr> <tr> <td>000: OMR no adjusting</td> <td>76</td> <td>016: OMR adjustment new</td> <td>77</td> </tr> <tr> <td>000: 2 ONLINE fct.</td> <td>96</td> <td>032: 3 ONLINE fct.</td> <td>97</td> </tr> <tr> <td>000: search paper-start</td> <td>38</td> <td>064: no searchIng paper start</td> <td>39</td> </tr> </tbody> </table> <p>Table for display O:</p> <table border="1" style="width: 100%; text-align: center;"> <thead> <tr> <th>ID-Value</th> <th>Service-No.</th> <th>ID-Value</th> <th>Service-No.</th> </tr> </thead> <tbody> <tr> <td>000: old PCB</td> <td>100</td> <td>001: new PCB with pressure sensor</td> <td>101</td> </tr> <tr> <td>000: sheet stops at blade</td> <td>102</td> <td>002: sheet hangs further out</td> <td>103</td> </tr> <tr> <td>000: standard</td> <td>104</td> <td>004: OMR 2-up 16+16 special</td> <td>105</td> </tr> <tr> <td>000: OMR up to 16+16</td> <td>106</td> <td>008: OMR routine 9 48+48 marks</td> <td>107</td> </tr> <tr> <td>000: Paper lead-edge + presence sensor active</td> <td>108</td> <td>016: Paper lead-edge + presence sensor shut off</td> <td>109</td> </tr> <tr> <td>000: OMR not crossed</td> <td>130</td> <td>032: OMR head 6-7 swapped over</td> <td>131</td> </tr> <tr> <td>000: OMR 1 head</td> <td>132</td> <td>064: OMR 2 heads</td> <td>133</td> </tr> <tr> <td>000: OMR 2 head 8+8</td> <td>134</td> <td>128: OMR 2 heads 16+16</td> <td>135</td> </tr> </tbody> </table>	<sup>0</sup> A B	<sup>1</sup> C D	<sup>2</sup> EFGH	<sup>3</sup> IJKL	<sup>4</sup> M	<sup>5</sup> NOPQ	- +	- +	- +	- +	- +	- +	ID-Value	Service-Nr.	ID-Value	Service-Nr.	000: START/STOP possible	68	001: START/STOP not possible	69	000: eject last sheet	66	002: no paper ejection	67	000: no match code	64	004: Match code output dir.	65	000: fine pos. normal	74	008: Finepos. * 2	75	000: OMR no adjusting	76	016: OMR adjustment new	77	000: 2 ONLINE fct.	96	032: 3 ONLINE fct.	97	000: search paper-start	38	064: no searchIng paper start	39	ID-Value	Service-No.	ID-Value	Service-No.	000: old PCB	100	001: new PCB with pressure sensor	101	000: sheet stops at blade	102	002: sheet hangs further out	103	000: standard	104	004: OMR 2-up 16+16 special	105	000: OMR up to 16+16	106	008: OMR routine 9 48+48 marks	107	000: Paper lead-edge + presence sensor active	108	016: Paper lead-edge + presence sensor shut off	109	000: OMR not crossed	130	032: OMR head 6-7 swapped over	131	000: OMR 1 head	132	064: OMR 2 heads	133	000: OMR 2 head 8+8	134	128: OMR 2 heads 16+16	135
<sup>0</sup> A B	<sup>1</sup> C D	<sup>2</sup> EFGH	<sup>3</sup> IJKL	<sup>4</sup> M	<sup>5</sup> NOPQ																																																																														
- +	- +	- +	- +	- +	- +																																																																														
ID-Value	Service-Nr.	ID-Value	Service-Nr.																																																																																
000: START/STOP possible	68	001: START/STOP not possible	69																																																																																
000: eject last sheet	66	002: no paper ejection	67																																																																																
000: no match code	64	004: Match code output dir.	65																																																																																
000: fine pos. normal	74	008: Finepos. * 2	75																																																																																
000: OMR no adjusting	76	016: OMR adjustment new	77																																																																																
000: 2 ONLINE fct.	96	032: 3 ONLINE fct.	97																																																																																
000: search paper-start	38	064: no searchIng paper start	39																																																																																
ID-Value	Service-No.	ID-Value	Service-No.																																																																																
000: old PCB	100	001: new PCB with pressure sensor	101																																																																																
000: sheet stops at blade	102	002: sheet hangs further out	103																																																																																
000: standard	104	004: OMR 2-up 16+16 special	105																																																																																
000: OMR up to 16+16	106	008: OMR routine 9 48+48 marks	107																																																																																
000: Paper lead-edge + presence sensor active	108	016: Paper lead-edge + presence sensor shut off	109																																																																																
000: OMR not crossed	130	032: OMR head 6-7 swapped over	131																																																																																
000: OMR 1 head	132	064: OMR 2 heads	133																																																																																
000: OMR 2 head 8+8	134	128: OMR 2 heads 16+16	135																																																																																

1) The DA values (IJKL) are only shown in forms cutters with a new main board (no pots.)

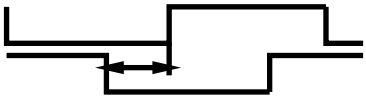
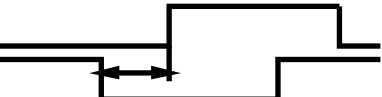
Service routine no.	Function	Display when a service routine is started	Comments
010 2)	Automatic adjustment Opto 1-4		 <p style="text-align: right;">A:B =</p> <p>50:50 Set value = 050 (045-055 tolerance range) <b>Caution:</b> Do not start the machine before carrying out the following precautionary measures: Check the distance between the heads and the encoder disk (0,3mm). Make sure the fibre-optic is correctly plugged in. Lower blade test run: Upper blade must move freely to meet lower blade (fix the cable clamp between blade bar and adjusting screw). If service routine 10 is finished, the display changes into service no 9 level 3 and shows the DA values. The DA-values should not be over 200. (for further information see pt. 4.4, S.52). Press the "Prog"-button two times and start service routine no 000 to return to the program.</p>
011	Opto 1 Adjust cross cutter	000-100 display range	
012	Opto 2 Adjust cross cutter	000-100 display range	
013	Opto 3 Adjust tractor	000-100 display range	
014	Opto 4 Adjust tractor	000-100 display range	
015	Opto 5	000, 002	Not in use at present
016	Opto 6 OMR		Like service 17 for head 6
017	Opto 7 OMR Test routine (machine must be switched off - unplug online machines)	000-015 display range	Binary addition of the OMR marks recognized. In this test a maximum of four marks are read (in four successive lines, AL + 3 lines). Before the test routine is started, the adjustment line (AL) of the test form must be positioned in the groove on the reading head. Caution! The machine must be switched off - unplug all online machines. Then start the test routine. 001 = first OMR mark (AL), 002 = second mark, 004 = third mark and 008 = fourth mark. Altogether 015. In a correct reading operation the result shown in the display must be stable.
018	Opto 8 End of paper	000 001	No paper Paper present
019	Hall sensor cover	000 001	Plexiglass cover closed Plexiglass cover open
020	Hall sensor pressure-switch	000 008	008 pressure ok
021	Opto 1-2 Phase position cross cutter	000-100 display range	Set value = 040 (030-065 tolerance range ) <b>Caution:</b> Service routine 10 must be started first! 
022	Cross cutter - motor	001-255 display range	Motor test, together with test of electric drive circuits.
023	Opto 3-4 Phase position tractor	display range	6609/10: Set value = 040 (030-055 tolerance range) 6611/12: Set value = 040 (030-050 tolerance range) <b>Attention:</b> You will have to START with Service Routine 10 first! 
024	Tractor motor	001-255 display range	Motor test, together with test of electric drive circuits.
025	Edge knife and ejector motor	001-255 display range	Motor test, together with test of electric drive circuits.
026 3)	Motor test 8V	001-255 display range	Motor test: Use extension to plug motor into ejector socket, and with your hand hold the belt pulley still. If the pulley makes jerky movements this is an indication of faulty winding.

2) Only for forms cutters with new main board (no pots.)

3) Only for forms cutters with central computer chip "H..... 42/94"

Service routine no.	Function	Display when a service routine is started	Comments
027 3)	Motor test 12V	001-255 display range	Motor test: use the extension to plug motor into ejector socket, and with your hand hold the pulley still. If the pulley makes jerky movements this is an indication of faulty winding.
028 4)	Temperature sensor	001-255 display range	The numbers in the display correspond to the following room temperatures: 145 20 C; 150 30 C; 160 40 C; 170 50 C; From number 154 (corresponds to 35 C) onward, the feed rate will automatically be reduced in steps.
030	Clear display RAM	OK	<b>Caution:</b> When this service no. is started, all programs are erased.
031	Erase OMR routines 2-6	OK	<b>Caution:</b> When this service no. is started, all OMR routines (2-6) are erased. OMR routine 1 is a fixed program and will be reloaded when the machine is switched on (even after erasing).
032 to 036	Erase one OMR routine	OK	E.g. Service no. 032 erases OMR routine 2. Service no. 033 erases OMR routine 3, etc. OMR routine = service no. minus 30
038	Find beginning of paper after program change	see service routine 9 table N	The paper is repositioned automatically on the blade edge when the program is changed.
039	Do not search for beginning of paper after program change	see service routine 9 table N	The paper is <b>not</b> repositioned automatically on the blade edge when the program is changed.
040 to 043	Display OMR code Current cycle	000-255 display range	040 = the first 8 OMR marks, 041 = the next 8 OMR marks , etc. The same applies to service nos. 044-047, 048-051, etc.
044 to 047	Display OMR code 1 sheet before	000-255 display range	Example: Service no. 040 and display 017 017 is composed of 001 + 016. Thus OMR marks have been detected in line 1 (1) and line 5 (16) (binary addition of the marks). The adjustment line (AL) contains the first mark.
048 to 051	Display OMR code 2 sheets before	000-255 display range	
052 to 055	Display OMR code 3 sheets before	000-255 display range	
056 to 059	Display OMR code 4 sheets before	000-255 display range	
060 2)	OMR sensitivity level 0	000	000 = low sensitivity (recommended for <b>90% of all applications</b> ).
061 2)	OMR sensitivity level 1	001	Can be checked again in service routine 009 (2/F). The new sensitivity level will be transferred only after the machine is switched on again.
062 2)	OMR sensitivity level 2	002	
063 2)	OMR sensitivity level 3	003	
064 4)	Match code	see service routine 9 table N	The group match code must be programmed, it will not be output directly.
065 4)	Match code		The group match code will be read in lines 4-16 <b>without</b> programming and will be output directly.
066 4)	Eject last sheet (>8")	see service routine 9 table N	The last cut sheet (> 8") is transported off the Automatic Forms Cutter and put to the ONLINE-Systems. Sheets < 8" remain in the Automatic Forms Cutter - they were not ejected.
067 4)	Not eject last sheet		The last cut sheet (< oder > 8") is not ejected - remains in the Automatic Forms Cutter.

2) Only for forms cutters with new main board (no pots.)

3) Only for forms cutters with central computer chip "H..... 42/94"

4) Only for forms cutters with central computer chip "H.....47/95"

Service routine no.	Function	Display when a service routine is started	Comments
068 4)	Start/Stop	see service routine 9 table N	The Start/Stop button can be used during online operation.
069 4)	Start/Stop		The Start/Stop button cannot be used during online operation.
070	Find beginning of paper automatically	OK	
071	Position beginning of paper manually	OK	
074 4)	Fine position normal	see service routine 9 table N	In parameter <b>h) Fine Position</b> , the values entered will be used unaltered.
075 4)	Fine position x2		In parameter <b>h) Fine Position</b> , the values entered will be multiplied by factor 2.
076 4)	OMR intermediate adjustment off	see service routine 9 table N	No intermediate stroke to adjust position of OMR marks.
077 4)	OMR intermediate adjustment on		After every 1024 strokes, one intermediate stroke to adjust position of OMR marks when reader is being used.
078 5)	Display darker	244-004	The language in the display can be changed by activating the appropriate service routine.
079 5)	Display brighter	004-244	
080 5)	Language: German	000	
081 5)	Language: English	001	
082 5)	Language: French	002	
083 5)	Language: Italian	003	
084 5)	Language: Dutch	004	
085 5)	Language: Portuguese	005	
086 5)	Language: Spanish	006	
087 5)	Language: Norwegian	007	
088 5)	Language: Japanese	008	
089 5)	Language: Swedish	009	
090 5)	Language: Czech	010	
096	ONLINE function	see service routine 9 table N	A maximum of two online functions can be performed with the counter.
097	ONLINE function		maximum of three online functions can be performed with the counter.
098	Fine offset +1		After changing or replacement of the cross-cutter subassembly (complete block) the new cut-position has to be fine-adjusted again. The form is positioned on the blade edge. When service routines 98 or 99 are started, the distance between light barrier (paper recognition) and cut position is adjusted. In parameter <b>h)</b> the fine position is correctly set at factor 00 after fine offset. Fine offset +1: The distance from light barrier to cut position is increased by factor 1 (corresponds to 1/192"). Fine offset -1: the distance from light barrier to cut position is decreased by factor 1 (corresponds to 1/192").
099	Fine offset -1		
100	Set board (PCB) Set board without temperature and pressure sensor.	see service routine 9 table O	PCB version installed previously without control, (for machines without fan for the motors, but with NEW PCB)
101	Set board (PCB) Set latest board version with temperature and pressure sensor.		Newest board version with temperature and pressure sensor.

4) Only for Automatic Forms Cutter with central computer chip "H.....47/95"

5) From new display board 16060 onward.

Service routine no.	Function	Display when a service routine is started	Comments
102	Standard	see service routine 9 table O	For standard uses - sheet does not hang so far out of the forms cutter (lies over both rollers in the cross cutter)
103	Paper hangs further out of the forms cutter		Sheet hangs further out of the forms cutter (is only held by the last roller). In order to avoid paper jams at the entry to the conveyor stacker 6624, 6625 or drop stacker 6650, 6651 when operating at high speed, a greater distance between sheets is required. This adjustment will be transferred only when the Forms Cutter is switched on again.
104 105	Standard 2-up special	see service routine 9 table O	OMR Standard 2-up-16+16 special
106 107	Standard 48+48 marks		8+8 / 16+16 Service 134/135 apply 48+48 lines (OCB)
108 109	Paper lead-edge + presence sensor active Paper lead-edge + presence sensor shut off	see service routine 9 table O	Standard: checks for lead-edge and end-of-paper  The sensor is switched off during continuous run. After the paper has been positioned to the blade or read-head (Display shows 'READY') the sensor will be inoperative. <b>Notice:</b> The cutter will NOT stop at the end of paper / end-of-web! <b>Use this feature for:</b> paper backside with solid black printing or holes in the paper web.
114 115	Doublecut Increase	see service routine 9 / P	Doublecut - Offset adjustable - 1/24" +1/ 24"
130 131	Standard 6-7 not crossed head 6-7 swapped over	see service routine 9 table O	The right hand OMR head is connected to LED-block input 7, the left head to input 6. Head 7 is read first.  The two head 6-7 are swapped over, so 6 becomes 7 and 7 becomes 6 in the Software.
132 133	Standard 1head 2 heads	see service routine 9 table O	1-head OMR heads 6-7 2-head OMR, (see service 134/135) may be swapped serv. 130/131
134 135	Standard 8+8 16+16 marks	see service routine 9 table O	with 2-head OMR: 8+8 marks (Sequencer Digi "0") with 2-head OMR: 16+16 marks (Sequencer Digi "1")
201 to 215	Interface Transmit equipment address	201-215 display range	interface diagnostic: continuous emission of adress # = service # - 200
255	Show connected interface participants	001-015 display range	Equipment addresses: 001 - master terminal, 002 - main board, 003 - terminal, 004 - remote control, 005 - remote control, 008 - drop stacker, 010 - loop control, 013 - group separation, 014 - drop stacker conveyor, 015 -online equipment.

### 3.4.2 Messages

The messages appear from the following software version onwards:  
 Central computer chip "H ..... 46/92" ("H 133")  
 and display chip "D ..... 05/93"

Display after switching on or during operation	Function	Comments
007	ID chip	ID chip missing or interface blocked
011	Opto 1 - Cross cutter	Start service no. 011 (adjust opto 1)
012	Opto 2 - Cross cutter	Start service no. 012 (adjust opto 2)
013	Opto 3 - Tractor	Start service no. 013 (adjust opto 3)
014	Opto 4 - Tractor	Start service no. 014 (adjust opto 4)
021	Opto 1-2 Phase position	Start service no. 021 (opto 1-2, phase position: adjust distance between the two scanner heads)
022 2)	Overcurrent at cross cutter motor	Cause: Cross cutter is too stiff, motor is blocked, winding or final stage is defective
023	Opto 3-4 Phase position	Start service no. 023 (opto 3-4, phase position: adjust distance between the two scanner heads)
024 2)	Overcurrent at tractor motor	Cause: Motor is blocked, winding or final stage is defective
025 2)	Overcurrent at ejector motor	Cause: Motor is blocked, winding or final stage is defective
026	Overcurrent at edge blade turbine motor	Cause: Motor is blocked, winding or final stage is defective
031 2)	Opto 1 - Cross cutter	DA value outside permissible range Cause: Dirt on encoder disk or fibre-optic Distance at scanner head not correct Fibre-optic not plugged in Power supply interrupted  After correcting the problem, start service routine 10.
032 2)	Opto 2 - Cross cutter	
033 2)	Opto 3 - Tractor	
034 2)	Opto 4 - Tractor	
040 8)	Revolution - Controll	Cause: Cross cutter is too stiff, motor is blocked, winding or final stage is defective
099 7)	Supplementary cooling fan defective	The supplementary cooling fan for models 6611, 6612 and 6613 is tested with a pressure sensor to check whether it is functioning correctly. If the pressure is not sufficient, the interface to the terminal will be blocked. The message 099 Call Service! will appear in the display. Operation cannot be continued, The forms cutter must be switched off. Cause: Defective motor, air distribution channel not correctly installed, or motor not plugged in.

2) Only for forms cutters with new main board (without pots.)

7) Only forms cutters 6611/6612, from display chip "D 16061 39/94" onward

8) Only for forms cutters with cross-cutter chip "Q .....08/00"



## 4. Important notes and information

### 4.1 Cleaning and maintenance

The maintenance periods given here are based on a daily use of approx. 4 hours. If the system is in operation longer, you will need to maintenance it more frequently.

For example:

If used for four hours a day for DIN A4 format with two cuts, this adds up to approx. 60,000 machine cycles (mod. 6611) and approx. 120,000 cutting cycles. Over a period of one month (20 working days), this is equal to over two million cutting cycles.

The following maintenance plan is appropriate for this amount of use:

Every month: replace or turn around the blades (cross cutter and edge cutter).

Approx. every 4 months: replace the rear cutter guide bar.

Approx. every 12 months (approx. 20 millionen cuts): replace motors.

**To ensure trouble-free operation, replace parts subjected to high loads before they fail!**

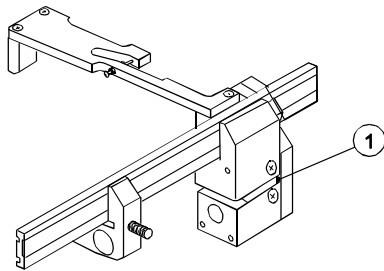

**We recommend that the operator perform the following maintenance work after every 500,000 cuts.**

1. Clean all areas accessible from outside with a vacuum cleaner. Do not use compressed air.
2. Apply two drops of oil to each edge cutter unit and to the centre cutter 6875 (if present).

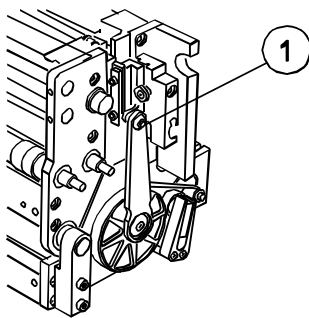

**The following maintenance work should be performed by a service technician every 2 million cutting cycles:**

If necessary, replace or turn around the edge and cross cutter blades (see Service Instructions). Clean the sliding surfaces of the cross blade, inspect for wear and grease lightly (if necessary, replace the rear cutter guide bar). Apply one drop of oil to the upper pivot pins of the connecting rod on the cross cutter drive. Wipe away any excess oil which drips onto the connecting rod.

**The following maintenance work should be performed by a service technician every 3 months (every 5-6 million cutting cycles):**

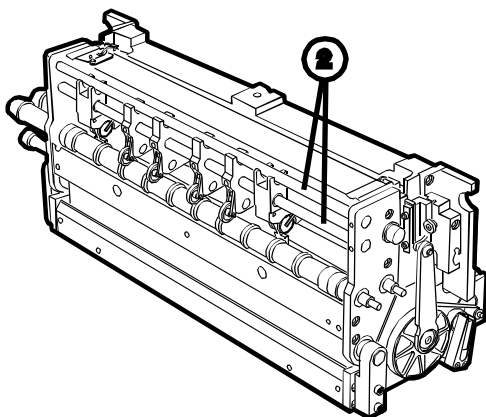

1. All maintenance work performed by the operator.
2. Use a vacuum cleaner to clean the machine inside and outside. Do **not** use compressed air.
3. Clean both encoder disks and the scanning heads on the cross cutter and tractor (see Service Instructions).
4. Inspect the flat belts and make sure they are still centered. Remove any dirt which may have accumulated on the running surfaces.
5. Begin service routine 10 and adjust the machine automatically. If service routine 10 is finished, the display changes into service no 9 level 3 and shows the DA-values. The DA-values should not be over 200. (for further information see pt. 4.4, S.52). Press the "Prog"-button two times and start service routine no 000 to return to the program.
6. Check that the tractors and edge cutter units stop correctly. Adjust them if necessary.
7. Grease hexagonal shafts and both shafts.

## 4.2 Troubleshooting

Problem	Causes and Solution
Machine always runs in reverse on starting Forms cutter does not stop at end of paper	End-of-paper light barrier is covered by paper-holder. End of paper cannot be detected, Adjust the paper-holder vertically downwards. The light barrier must not be covered.
	Light barrier is covered with paper dust and end of paper cannot be detected. Clean the light barrier.
	The height of the light barrier has been altered. End of paper cannot be detected. Inform the service technician.
Forms are not cut straight	Inform the service technician.
Forms are not cut	Check the cut width factor (NO CUT means edge cut only)
Programs cannot be copied	You are not in the programming level (see Section 3.3)
Service routines cannot be called	Check whether you are in the technician level. For further information, see Section 3.4.
Machine stops without any message	Form is not being called by other equipment connected to the form cutter. The equipment is out of order, is not properly connected or is set at <b>Stop</b> . Check the equipment.
Display messages: see Section 3.1.3, page 14	
Read errors: see Section 3.3.2, page 29	

## 4.3 Technical Data

### Number of cuts per hour

Model:	6609	6610	6611	6612
Type of cut:	Single Double	Single Double	Single Double	Single Double
Form length:				
4"	17000 13000	20000 15000	23000 17000	27000 20500
8"	11000 9500	15000 12000	18000 14000	24000 17500
12"	8000 7500	12000 10000	15000 12000	18000 14500

These performance figures may vary by – 5% and represent machine cycle performance only (without paper).

Form length:	min. 12/6" max. 999/6"	Paper weight:	min. 40 g/m <sup>2</sup> max. 200 g/m <sup>2</sup>
Form width:	min. 88 mm max. 500 mm	Basis weight for multipart forms:	max. 350 g/m <sup>2</sup>
Edgetrim:	28mm (option 60 mm)		
Cuttingtolerance:	– 0,3 mm		

#### Standard

Input terminal  
Transp. cover w. auto stop  
Rim chopper  
Automatic stop at end of paper  
Self diagnostic center  
Electronic fine adjustment  
High speed interface  
(other forms processing systems can be connected to high speed interface - 6610, 6611, 6612 and 6613 with online interface)  
Multifunction counter  
Length steps 1/6", 1/8", and 1/24"  
Stand

#### Option

Interface to Inserters  
Stacker tray  
Automatic lowering stacker  
OMR reader (programmable)  
Center Slitter  
Additional Vertical Slitter  
Group separation  
Tension control  
Remote control

#### Dimensions

Width without/with input terminal: 760/850 mm  
Height without/with input terminal: 1090/1200 mm  
Length without/with standard tray: 525/960 mm

#### Weight

Form cutter incl.  
Stand: 80,0 kg  
Stacker tray/standard: 5,0 kg

**Finish** Two colours

#### Connected loads:

Single-phase a.c.	50/60 Hz
Voltage:	115V / 230 V
Power consumption during continuous operation:	600W/2160 kJ/h (depending on cycle speed and number of systems connected)
Stand by:	50 W
Noise level:	68 dB/A

Subject to alteration

## 4.4 Technical change of the main PCB-s

The actual delivered Automatic Forms Cutter (dated week 43/2000) are with a potentiometer (to adjust the optical power) on the main PCB.

The reason for this change is the ageing of the light emitting diodes (LED-s) used in the LED block. The optical power of the LED-s decreases faster, ages faster, as specified by the manufacturer! As consequence, after several years of using, the head unit (Mod. 6600 Automatic Forms Cutter , Mod. 6618 Pinless-Cutter , Mod. 6683 Cut-Sheet-Feeder or Mod. 6790 Cutsheet Guillotine shows the error message 31, 32, 33, or 34. That means the DA-values are not within the allowed range. (Further reasons for this error message are: dirt on encoder disc, distance between scanner head and encoder disc is not correct or encoder disc is scratched.) This also has not change after this modification. Please really note the technical service manual.

In addition to the above mentioned potentiometer, which is mounted from now on, we changed software details, which are not visible from outside. The control range was extended, so in future times the space of time the error message 31-34 appears is widened (caused by deviating DA-values!). In addition the DA-values are now directly shown on the display after running "service routine 10" (during turn of the Poti). Please note that the displayed values (for every channel one value) can always be different. By manufacturing tolerances of the semiconductors and of the fibre cable, always individual differences result within the 4 channels! Independent of this, the DA-values should be between 70 and 130 - Total control range up to 250 (Important: Adjust the machine at room temperature)! This range was settled new!

If the adjusted values are lower than 70 the Poti must be turned to the left (lower optical power!). More than 130 - turn the Poti to the right (more optical power!). After poti adjustments service "routine 10" must always be restarted in order to adjust the new actual DA-values automatically.

If the deviation between the 4 channels (no more in the range 70-130 = approx. 40 DA-points difference) is too high, it is recommended to change the deviating channel. The fibre cable or the light emitting diode or the detector diode.

With the technical modifications described above, it is possible for the service technician on site to carry out themselves the corresponding adjustments and as result extend the period essentially, until the light emitting diodes must be changed.

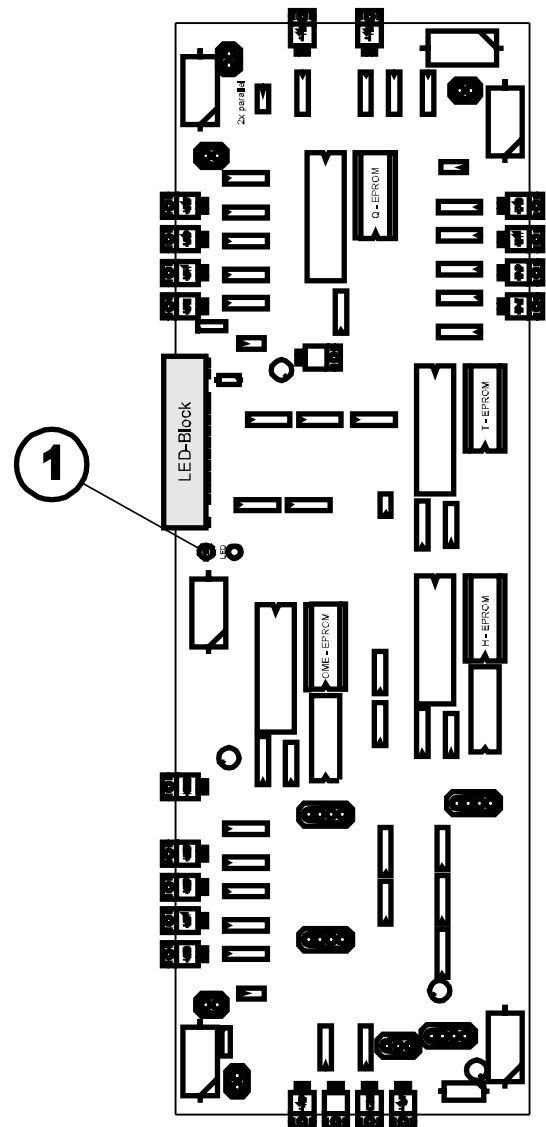

4.4.1 Connections and electrical settings

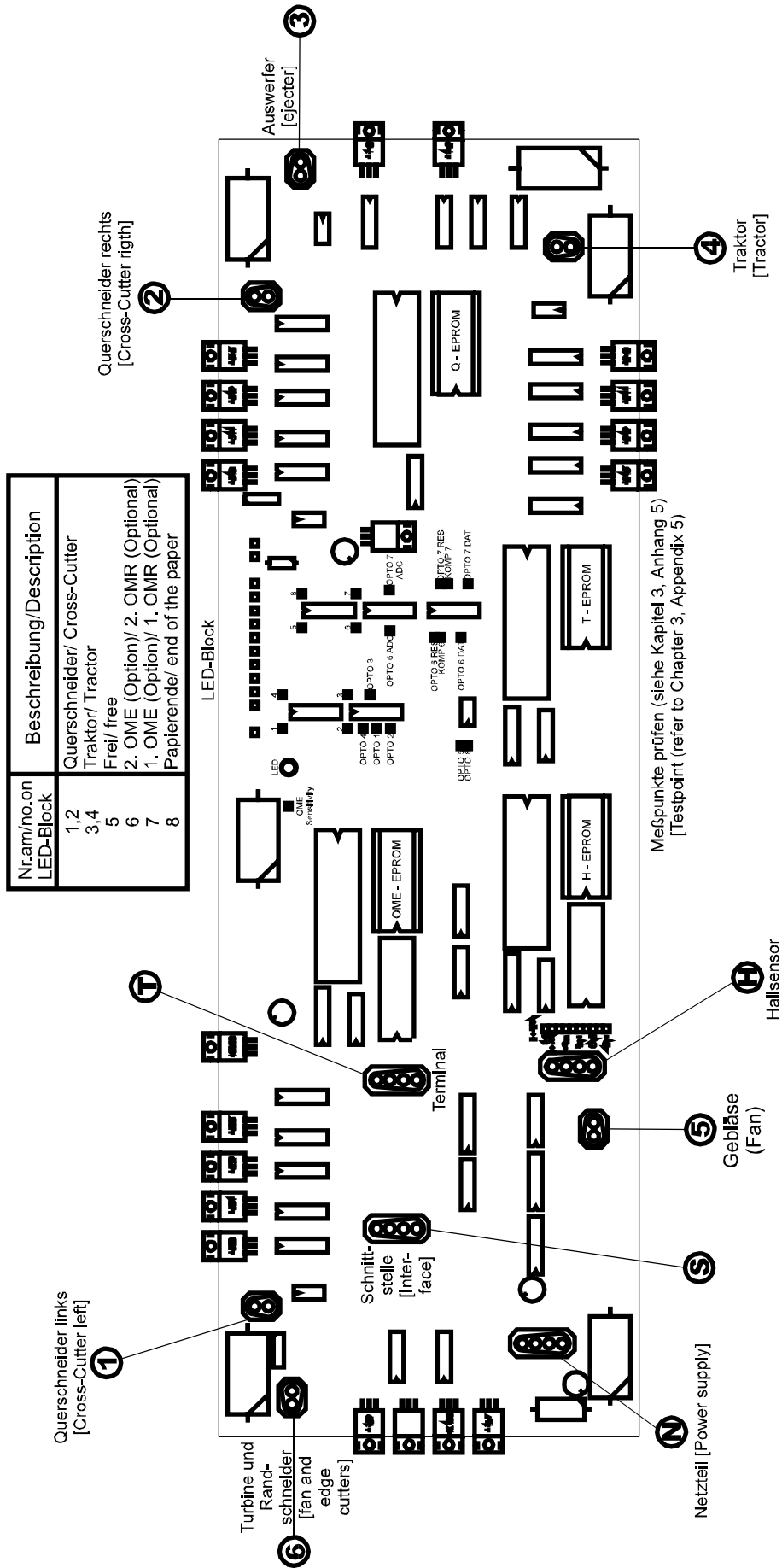

No.	Description	Mod. 6609/10 Part no. for motor (Ø belt pulley)	Mod. 6611/12 Part no. for motor (Ø belt pulley)
	Motor for Cross-Cutter left	20599 (Ø 16)	15250 (Ø 21)
	Motor for Cross-Cutter right	20599 (Ø 16)	15250 (Ø 21)
	Motor for ejecter	20599 (Ø 18)	15250 (Ø 24)
	Motor for Tractor	20599 (Ø 18)	15250 (Ø 24)
	Motor for fan	26199 (Ø 30)	26199 (Ø 30)
	Motor for fan and edge cutters	10179 (Ø 9)	10179 (Ø 14)
T	Terminal		
H	Hallsensor		
S	Interface		
N	Power supply		

## Index

Actual counter	20	OMR data list	39
Adjustment	10	OMR mark	32
Adjustment line	30	OMR routines	29
Assembly	6	Online	40
Call service	16	Operating terminal	13
Checking parts	5	Operation	13
Code	30	Operator level	16
Connected loads	50	Optical mark recognition	29
Connections and electrical settings	53	Optical scanner	10
Cooling fan	16	Panel keys	14
Copy	27	Paper	14
Counter	20	Paper adjustment	10
Counter function	21	Paper guide	9
Cover	16	Parameters	13
Cross blade	10	Pause	24
Cross cut position	20	Print lines	29
Cross perforation	10	Prog button	14
Cut	17	Program selection	13
Cutting program	13	Program sequence	13
Dimensions	50	Program structure	13
Direct channel	30	Programming level	22
Display	16	Programming the fold length	22
Display messages	16	R	15
Double cut	17	Read area	30
EC Declaration of conformity	4	Read lines	32
Edge blade	10	Reader	24
Edge cut	17	Reading mark	29
Entering parameters	16	Ready	14
Fault location	48	Safety instructions	5
Features	50	Select program	9
Feed rate	24	Service routines	41
Fine position	27	Single cut	17
Flashing	13	Special Length	17
Form length	16	Speed	24
Function	30	START button	14
ID chip	16	Starting the machine	9,12
Info button	16	Starting up	9
Inserting the paper	9	Stop	14
Interface	16	STOP button	14
Label	20	Sub counter	20
Length	16	Switching on	9
List of contents	2	Technical change	52
Loading paper	9	Technical Data	50
Location	5	Technician level	41
Maintenance	48	Test cut	13
Notes	48	Tractors	9
Number of cuts	50	Weight	50
OMR code	32		